



GALVANIZING

HANDBOOK

Foreword

Steel is the most used construction material today. It has many advantages, but unfortunately also a big disadvantage - it corrodes. To get a long, maintenance-free service life of the construction a reliable corrosion protection is of high importance, and this is where the hot dip galvanizing enters the context. By dipping the construction in molten zinc it get both externally and internal corrosion protection with very good resistance. Hot dip galvanizing is used for a wide range of products, from small fasteners to large beams, bridge segments, roof trusses, lamp posts, road blocks and facade elements. The possibilities are endless. Where steel is used hot dip galvanizing often has an important complementary role.

This handbook is published by Nordic Galvanizers, the branch association for galvanizing companies in Nordic countries. For more information, see the Association's website, www.nordicgalvanizers.com.

Nordic Galvanizers runs an information office in Stockholm where our members' customers are welcome to turn to for questions regarding choice of steel, structural design, standards, corrosion categories, environmental issues and other things related to hot-dip galvanizing of steel. Nordic Galvanizers also arranges conferences for member companies where technology development and production enhancements are presented, as well as participating in international cooperation through European General Galvanizers Association, EGGA.

By choosing a galvanizer who is a member of Nordic Galvanizers you as a user ensures that your product is galvanized with quality and environmental awareness in mind. You can also quickly get help and answers to issues related to the product, either from your galvanizer or from Nordic Galvanizers information office.

This Handbook was first published in 1968, entitled "Hot-dip galvanizing for corrosion protection." It was received with great interest, and has since then been revised eight times and published in seven different languages.

This seventh edition has taken into account the recent years' technological development as well as news when it comes to environmental issues. The handbook is based on research, experiences and information from people in the industry. It is our hope that this handbook, like the earlier editions, will give pleasure and assistance to those who are interested and engaged practically in problems to do with the protection of steel against corrosion.

Stockholm in June 2019



Annikki Hirn

Table of contents

1. About rust and rust prevention

2. Choice of rust prevention method

3. Protection methods

- 3.1 Hot-dip galvanizing
- 3.2 Electroplating
- 3.3 Zinc spraying
- 3.4 Sherardizing
- 3.5 Mechanical plating
- 3.6 Coating with zinc-rich paint

4. Hot-dip galvanizing

- 4.1 Advantages and limitations
- 4.2 Process
 - 4.2.1 Hot-dip galvanizing of small components
 - 4.2.2 Wire and tube galvanizing
 - 4.2.3 Sheet galvanizing

5. The reaction between iron and zinc

- 5.1 The structure of the layer
- 5.2 Aluminium-killed steels
- 5.3 Steels in "Sandelin range"
- 5.4 Silicon-killed steels
- 5.5 Influence of alloying elements in the steel
- 5.6 Influence of other factors
- 5.7 Influence of alloying elements in the zinc melt
- 5.8 Choice of steel
 - 5.8.1 Aluminium killed steel with lower reactivity than expected
 - 5.8.2 Risk of Sandelin Effect
- 5.9 The iron-zinc reaction in strip galvanizing

6. The strength of hot-dip galvanized steel

- 6.1 Tensile strength, notch toughness and ductility
- 6.2 Weld stresses
- 6.3 Fatigue strength
- 6.4 Brittleness and cracking
- 6.5 Hot-dip galvanized steel and fire
- 6.6 Hot-dip galvanized steel exposed to elevated temperatures
- 6.7 Durability against wear

7. Design and fabrication of structures

- 7.1 Safety requirements
- 7.2 Quality considerations
 - 7.2.1 Provisions for handling
 - 7.2.2 Mobility
 - 7.2.3 Avoid structures that can distort
 - 7.2.4 Avoid combining different materials and different surface conditions
 - 7.2.5 Avoid acid traps
 - 7.2.6 Overlapping surfaces
 - 7.2.7 Avoid pockets
 - 7.2.8 Threaded objects
 - 7.2.9 Marking
 - 7.2.10 Welding
 - 7.2.11 General

8. Standards

- 8.1 General requirements
- 8.2 Thicker coating than standardized
- 8.3 Other standards

9. Quality – control, testing and actions

- 9.1 Sectoral standards
- 9.2 Coating thickness
- 9.3 Coating surface appearance
- 9.4 Adherence between coating and steel
- 9.5 Actions in case of surface aberrations
- 9.6 Actions in case of damage
- 9.7 Approved Galvanizer

10. Corrosion of zinc coatings

- 10.1 Corrosion in the atmosphere
 - 10.1.1 Reddish-brown discolouration
- 10.2 Corrosion in liquids
 - 10.2.1 Wet-storage stain
- 10.3 Corrosion in soil
- 10.4 Galvanic corrosion
 - 10.4.1 Cathodic protection afforded by zinc coatings
 - 10.4.2 Galvanic corrosion of galvanized steel in contact with concrete embedded reinforcement
 - 10.4.3 Zinc coatings in contact with non-ferrous metals
- 10.5 Hot-dip galvanized steel in contact with building materials
 - 10.5.1 Mortar, plaster and wood
 - 10.5.2 Corrosion protection for reinforcing steel
 - 10.5.3 Hot-dip galvanized reinforcement in chloride environment
- 10.6 Packing and transporting of galvanized steel

11. Painting of hot-dip galvanized steel - Duplex system

- 11.1 Service life of the duplex system
- 11.2 Newly-galvanized, shiny surfaces
- 11.3 Exposed, matt surfaces
- 11.4 Cleaning and surface preparation
- 11.5 Choice of paint
- 11.6 Powder coating
 - 11.6.1 Pinholes
- 11.7 To consider when Duplex is used

12. Arc welding of zinc-coated steel – Spot welding

- 12.1 Spatter, penetration, pores and cracking
 - 12.1.1 Preventing spatter, reduced penetration, pores and inter-crystalline cracking
- 12.2 Choice of electrodes
- 12.3 Fumes
 - 12.3.1 Health effects of zinc oxide
 - 12.3.2 Protection from welding fumes
- 12.4 Spot welding

13. Bolted connections

- 13.1 Nuts and bolts
- 13.2 Contact surfaces
- 13.3 Inserting holes
- 13.4 Assembly

14. Economic aspects

- 14.1 Initial costs
- 14.2 Maintenance costs
- 14.3 Life time costs

15. Zinc in the environment

- 15.1 Introduction
- 15.2 Zinc in organisms
- 15.3 The bioavailability of zinc
- 15.4 Fields of application
- 15.5 Will zinc leave the galvanized surface?
- 15.6 Production and energy consumption
- 15.7 Recycling
- 15.8 Emission of zinc

16. Environmental information

- 16.1 Environmental activities in galvanizing
- 16.2 The product
 - 16.2.1 Product content
- 16.3 Packing and transporting
- 16.4 Material recycling and energy consumption
- 16.5 Production
 - 16.5.1 Emissions to air
 - 16.5.2 Emissions to water
 - 16.5.3 Energy consumption
 - 16.5.4 Noise and health
- 16.6 Environmental profile
 - 16.6.1 Environmental guidelines
- 16.7 Zinc in the environment
- 16.8 Environmental Product Declaration

17. References

1. About rust and rust prevention

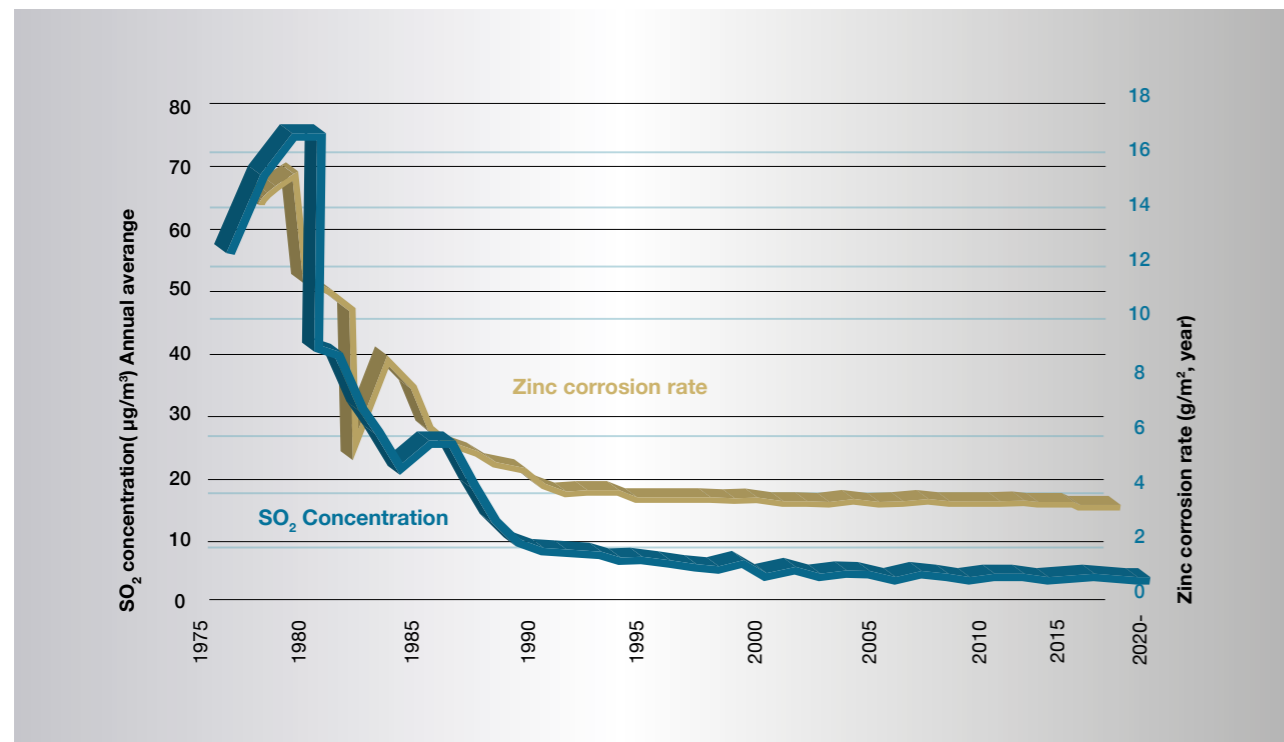

Fig. 1-1. Sulphur dioxide levels and zinc corrosion rates, in Stockholm, Sweden, 1977 - 2011.

In recent years, corrosion has decreased significantly in both the Nordic countries and across the rest of Europe. Several factors have contributed to this decrease, but the main cause is a decrease in sulphur dioxide levels in the atmosphere. The combustion of fossil fuels has decreased and those that are still in use have a lower sulphur content than previously. Fig. 1-1 shows the trend in zinc corrosion in Stockholm associated with the decrease in sulphur dioxide levels.

Corrosion is defined as a physicochemical reaction between a metal and its surroundings. The reaction is generally electro-chemical in nature. Corrosion usually results in damage to the function of the metal, damage to its surroundings, or damage to the technical system in which they are both included. Damage to a corroded construction is called primary damage whilst damage to other parts, caused by the primary corrosion, is called secondary damage. Secondary corrosion damage is often the most significant.

Broadly speaking, all metals, with the possible exception of precious metals, are corroded and destroyed with time.

Energy is used to extract metal from ore. The metal therefore represents a higher energy state than the ore. In corrosion the metal attempts to free this energy and revert to its natural and stable state. For this reason, the products of corrosion often resemble the compounds from which the metal was once derived.

However, the higher energy state on its own is not sufficient to enable corrosion to occur. For steel to corrode - or rust - in normal environments, it must have access to both oxygen and water. In most countries, both oxygen and water are available in sufficient quantities through most of the year to enable the corrosion process to take place.

Steel is without doubt the most highly utilized metal of our time. Its only great disadvantage is its tendency to corrode too quickly in many environments. The protection of steel structures and components from rust is therefore of great economic importance. The rusting process in steel can be impeded in any of the following ways:

- By alloying the steel. The chrome content can be varied and other metals such as nickel and molybdenum are often added to improve resistance to corrosion in different environments. For ordinary steel structures, however, these steels are too expensive.
- Changing of the corrosive environment through dehumidification, drying, temperature rising, or through the addition of inhibitors. The latter is very common in liquid environments. The disadvantage is that the methods are only usable within limited volumes.
- Cathodic protection through the utilization of sacrificial anodes or impressed direct current. The method using sacrificial anodes can be said to be a form of controlled galvanic corrosion, since the metals are arranged so that one of them is allowed to corrode while the other is protected. Cathodic protection can only be used in the presence of an electrolyte, such as water or moist soil. The method is used for the protection of ships, small boats, quays, offshore oil platforms, tanks, pipelines etc.
- Coating with inorganic or organic material, for the purpose of excluding humidity and oxygen from the steel surface. This is the most widely used method of protection against corrosion. The inorganic materials can be metals and vitreous enamels. The organic materials can be paints, bitumen products or plastics.

Metal coating of steel can be technically achieved with most metals in order to provide protection against corrosion, give wear resistance, and sometimes a decorative effect. However, many metals are expensive and/or difficult to apply to steel. Also, rust prevention can be less effective than desired due either to the coating metal itself being subject to corrosion or to it being more electro-positive than steel.

Only a few of the metals that can be deposited on steel are both economically acceptable and less electro-positive than steel (in "normal" conditions). In fact, only zinc and aluminium can really be considered. Magnesium might have been another candidate, were it not for its own excessive tendency to corrode and the difficulty of application. Cadmium was used to some extent at one time, but the high price of the metal and its poisonous nature has made it completely impractical, not least on environmental grounds.

Aluminium has a good bulk price and very good durability in most environments, although it is difficult to apply. At present partial aluminizing is performed, as far as is known, but not on an industrial scale. Thin sheet is aluminized on a small scale, though not in Scandinavian countries. Thermic spraying is used to a certain extent.

A more detailed analysis of the different aspects of corrosion and corrosion prevention would go beyond the scope of the publication. For those who are interested, further information about related problems can be found in the reference literature (1,2 and 3).



Fig. 1-2. On the left, a painted fence that has corroded. Compare with the hot dip galvanized fence on the right.

2. Choice of rust prevention method

When choosing a rust prevention method for a steel component or structure, there are many technical factors to be analyzed and tested. The environment in which the steel component or structure is to work must be studied carefully. Stress during transportation, storage, fitting or erection should also be investigated, especially if the structure is to be exported outside of Europe.

Further, an economic study of different prevention methods should be undertaken. It is important that the choice of method be based not only on initial costs, but also on packing costs for transportation, touch-up painting after erection and future maintenance costs. The initial costs alone make up only part

of the overall figure. Total costs over the entire service life of the structure can show something quite different.

Total life cycle costs include, in addition to the initial cost, costs for packing, transportation, repair after transport, installation, maintenance and environmental costs. For a design life requirement of 30 years for a construction, a paint system may require repairs or maintenance on two or three occasions and this will be much more expensive than the initial cost. This can be compared to use of a more durable corrosion protection system where no maintenance is needed. When the life time cost is used as a basis for calculations, a very different total cost is shown compared to when only initial application costs are used.

The official ISO Standard can be used to define the corrosion category for a given environment. Using the selected category, or environmental description, as a starting point the correct method of corrosion protection can be selected. It should be noted that the different classes in fig. 2-2 only describe functional environments. Construction, transport and assembly situations may influence the corrosion classification and should also be taken into consideration.

In fig. 2-3 a number of process variables for painting and hot-dip galvanizing are compared. For obvious reasons, the comparisons are general. Since paints and plastics are available in countless variations, with the different properties, conditions and demands being variable in practice, a comparison with actual parameters is often advisable.

It should be recognised that although paint and zinc are applied to a steel surface for the same reason - to protect against corrosion - they will act in a totally different way. The zinc coating will (very slowly) corrode from the outer surface towards the steel and also gives additional cathodic protection if the coating is damaged. Conversely, paint coatings are often destroyed through the development of a layer of rust between the paint and the steel. Since the paint coating gives no cathodic protection, rust is able to penetrate further beneath the paint coating once the coating has been damaged.

Corrosivity category	Corrosivity	Examples of environments	
		Outdoor	Indoor
C1	Very little		Heated buildings with dry air and insignificant amounts of pollutants, e.g. offices, shops, schools, hotels.
C2	Little	Environments with low levels of pollution. Mainly rural setting.	Unheated buildings with changing temperature and humidity. Low frequency off moisture condensation and low content air pollution, e.g. sports halls, warehouses.
C3	Moderate	Atmosphere with a certain amount of salt or moderate amounts of air pollution. Urban areas and slightly industrialized areas. Areas with moderate influence from the coast.	Buildings with moderate humidity and certain amount of air pollution from production processes, e.g. breweries, dairies, laundries, heated ice rinks.
C4	Large	Atmospheres with moderate amount salt or palpable amounts air pollution. Industry and coastal areas.	Buildings with high humidity and large amount air pollution from production processes, e.g. chemical industries, swimming pools, shipyards, non-heated ice rinks.
C5	Very large	Industrial areas with high humidity and aggressive atmosphere and coastal areas with a large amount salt in the air.	Buildings with almost permanent moisture condensation and large amount air pollution.
CX	Extreme	Industrial areas with extreme humidity and aggressive tropical or sub-tropical atmosphere. Offshore areas with a large amount salt in the air.	Industrial buildings with extreme humidity and aggressive atmosphere.

Fig. 2-1. Corrosion categories according to official ISO standard (4).

Corrosivity category	Mass loss for surface unit and thickness reduction (1 year of exposure)			
	Steel		Zinc	
	Mass loss (g/m ²)	Thickness reduction (µm)	Mass loss (g/m ²)	Thickness reduction (µm)
C1	≤ 10	≤ 1,3	≤ 0,7	≤ 0,1
C2	> 10 till 200	> 1,3 till 25	> 0,7 till 5	> 0,1 till 0,7
C3	> 200 till 400	> 25 till 50	> 5 till 15	> 0,7 till 2,1
C4	> 400 till 650	> 50 till 80	> 15 till 30	> 2,1 till 4,2
C5	> 650 till 1500	> 80 till 200	> 30 till 60	> 4,2 till 8,4
CX	> 1500 till 5500	> 200 till 700	> 60 till 180	> 8,4 till 25

Bild 2-2. Corrosion categories according to official ISO standard.

Factor	Paint System	Hot-dip galvanizing
Preparation	Blasting to Sa 2 ½. Unsatisfactory cleaning can reduce the service lifetime of the paint system by 60-80 %. Control of the preparation is crucial.	Pickling in acid is an essential part of the process. If the steel surface is not clean, no coating will be formed. Preparation control is not essential.
Process	Careful formulation, mixing, agitation, and correct thinning are factors of great significance.	The small variations that are possible have little or no influence of the quality on the zinc coating.
Application	The composition and uniformity of the coating varies with the method of application. Inspection of each stage of application is important. Sand-blasted surfaces are reactive and must be painted very soon after blasting.	The zinc coating is formed through a reaction between iron and zinc. The reaction is controlled by physical and chemical laws.
Application conditions		
1. Temperature	Good results are difficult to obtain if the air temperature is lower than + 10 ° or above + 30 °. Surfaces exposed to direct sunlight can easily become too hot.	Not affected by the air temperature or normal variations in the process temperature.
2. Humidity	Good results are difficult to obtain if the air temperature is lower than + 10 ° or above + 30 °. Surfaces exposed to direct sunlight can easily become too hot.	Not affected.
3. Air pollution	Steam, fumes, gases, dust and other pollutants have an adverse effect on the quality of the paint coating.	Not affected.
Type of steel	No influence	The content of, primarily, silicon and phosphorus in the steel affects the thickness and appearance of the coating.
Properties of the coating		
1. Thickness	Of great importance to service life. Varies with the number of layers and method of application. Inspection of thickness important for each layer.	The reaction between zinc and iron gives a certain standardized minimum thickness. Increased silicon content in the steel, increased mass and material thickness gives increased coating thickness.
2. Adhesion	Depends on preparation, type of paint system, interval between preparation and priming and hardening interval between layers.	The zinc coating is bound to the steel metallurgically..
3. Uniformity	The paint coating is thinner over corners and sharp edges. Holes and narrow crevices normally remain uncoated. "Shaded" sections can be subject to thinner layers.	Total coverage through dipping in molten zinc. Coating generally 50 % thicker over sharp edges.
Hardening time	Can vary, depending on type of paint and application conditions, from a few hours to several days for good handling characteristics, and up to several weeks for ultimate hardness.	The coating hardens completely within a few seconds of withdrawal from the zinc bath.
Deformations	None	Built-in stresses caused by cold working or welding can, in certain cases, be released so that some deformation occurs.
Inspection	Must be carried out after preparation and after each stage in the treatment to ensure good quality. Inspection of layer thickness upon application and on finished goods.	Visual control and measuring of layer thickness after treatment.
Risk of damage under transport and handling	Large. Can necessitate repair to primer coatings and complete overcoating.	Small. Coating withstands high mechanical stress. Minor damage does not need to be repaired. More serious damage must be repaired by means of spraying or coating with zinc-rich paint.

Fig. 2-3. Comparison between the characteristics and properties of paint and galvanizing.

3. Protection methods

3.1 Hot-dip galvanizing

Steel components that have been cleaned of rust, mill scale and other contaminants are dipped in molten zinc, producing a coating of iron-zinc alloys with pure zinc on the surface. Hot-dip galvanizing is the most commonly used method of rust prevention and is dealt with in more detail in Chapter 4.

3.2 Electroplating

The steel surfaces are degreased and pickled to remove rust and mill scale. The component is then submerged in a zinc salt solution and connected as a cathode to a direct current source. Rods or balls of pure zinc are connected as an anode (electrolytic zinc with purity 99,995%). The solution (electrolyte) can be acidic, neutral or alkaline, which determines the type of zinc salt. When the current is connected, zinc from the electrolyte is deposited on the steel surface. At the same time, the anode dissolves and supplies new zinc to the electrolyte.

The current efficiency, i.e. how much of the total current is used to deposit zinc on the steel surface, is of significance for steels that are sensitive to hydrogen embrittlement, since any excess current may generate hydrogen.

The components to be coated can either be supported in jigs or baskets or they can be placed in drums. The hanging devices or drums are then moved between the necessary baths — sometimes by a program-controlled robot.

The deposited layer has a very fine crystalline structure and adheres to the steel surface by mechanical means only. The standardized layer thicknesses (min. local thickness) are 5, 8, 12 and 25 µm. However, layers thinner than 5 µm can often be found on mass-produced items such as fittings, small bolts etc. Coatings thicker than 25 µm can only be obtained on components or structures of simple geometry, e.g. wire. For coating thicknesses over 15 µm is it often more economical to use hot-dip galvanizing instead of electroplating. It should also be noted that variations in coating thickness may

occur on electroplated components, depending on the shape of the item and the location of the anodes. Additional anodes may have to be used to deposit a coating on internal or shielded surfaces.

The surface of an electroplated zinc coating is very consistent, with a silvery, metallic sheen. Through the addition of special additives to the bath, very shiny coatings can be obtained (bright zinc). Electroplated components are usually dipped in chromate solutions to prevent corrosion during storage and transportation. The chromate layer is often colourless but can, in the case of thicker layers, be yellow-brown or green in colour.

Because of the thinness of the zinc layer, electroplated components are usually not suitable for outdoor applications or should be finished with a layer of paint or other organic coating prior to outdoor exposure in order to increase the service life.

3.3 Zinc spraying

The steel is cleaned by means of careful abrasive blasting — at least to Sa 2½, according to current standards. Zinc is fed into the spray gun in the form of wire or powder and melted by a gas flame or electric arc. The molten droplets are then sprayed on to the steel surface with the aid of compressed air.

The zinc layer can be somewhat porous and the surface coarse (Fig. 3-2 and 3-3). The thickness of the coating can be varied from about 30 µm to (in practice) about 300 µm. Adhesion to the steel surface is purely mechanical. To achieve corrosion protection in the same range as with hot-dip galvanizing the coating needs to be approximately 20 % thicker than a galvanized coating.

The method is suitable for larger objects of relatively simple shape. It is also well suited to the repair of zinc coatings on hot-dip galvanized components that have been damaged by mechanical impact or welding. See also reference 6.

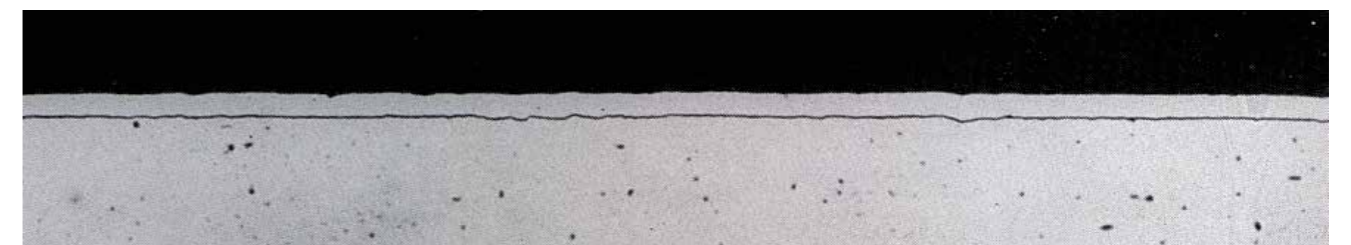
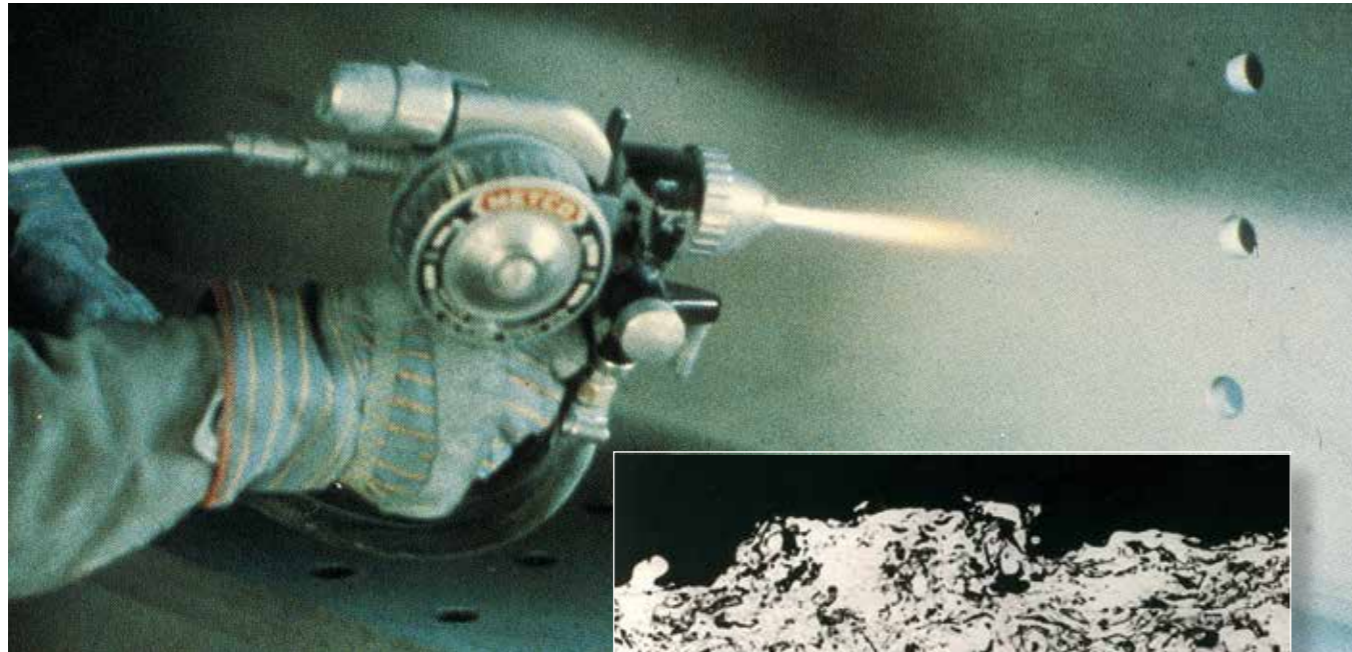

Fig. 3-1. Section through electrolytically applied zinc layer.



3-2. Zinc spraying.



Fig. 3-3. Section through zinc sprayed coating.

is necessary to enable the individual zinc particles to make good electrical contact with each other and with the steel surface. The paint can be applied with a brush or spray gun.

Painting with zinc-rich paint is sometimes called “cold galvanizing”. Obviously this is an attempt to give the impression that the zinc-rich paints give zinc coatings of a similar quality to those obtained by hot-dip galvanizing. However, this is not so, as can be seen in fig. 3-4. Coating with zinc-rich paint is a painting procedure and not a method of metal coating.

Zinc rich paint can be used to repair small areas of

damage to hot dip galvanized coatings. The repair should be made by brush and the coating thickness should be a minimum of 100 µm, in line with the requirements of EN ISO 1461. If the damaged area has to withstand pressure or mechanical load other repair methods are preferable.

The properties of zinc coatings applied by these various methods are given in fig. 3-5.



Fig. 3-4. Section through zinc-rich paint coating.

3.4 Sherardising

Steel components, cleaned through pickling, are packed together in a drum with zinc powder and sand. The drum is rotated and heated to just below the melting temperature of the zinc. During a period at this temperature, and with continued rotation, iron and zinc react with each other to form an iron-zinc alloy on the steel surfaces.

Sherardizing gives relatively thin coatings (15–40 µm) with dark grey surfaces. The coatings have good adhesion properties and a very uniform thickness, even on objects of complex shape. The method has about the same range of application as for electroplating. The international standard for coatings applied by sherardizing is ISO 14713-3. There is a limited use of the method in the Nordic countries.

Distek Thermodiffusion is a recent development of the sherardizing process. The process operates at temperatures in the range 320-450 °C.

3.5 Mechanical plating

Degreased objects are placed in a drum, together with glass balls. They are first tumbled in an acidic cleaning agent and then in a copper-plating agent.

The objects are then tumbled with zinc powder and certain activating chemicals.

Zinc is usually deposited in layers with thicknesses between 12 and 15 µm, although thicker layers of about 75 µm are said to be obtainable. The coatings are very uniform, even on objects of complex geometry but there are limits to the size of components which can be treated. The surface is matt. Since there is little risk of hydrogen embrittlement even hardened steels can be treated in this way.

There is no Nordic standard for this type of coating.

3.6 Coating with zinc-rich paint

As with zinc spraying, steel components should be cleaned by means of careful abrasive blasting – at least to Sa 2½, according to current standards. Scraping or wire-brushing alone does not give satisfactory results.

Zinc-rich paint consists of fine grained zinc powder in an organic or inorganic bonding agent. Both one and two-component paints are available. The zinc content in the dry paint film should be at least 92 % by weight, which corresponds to 62 % by volume. This

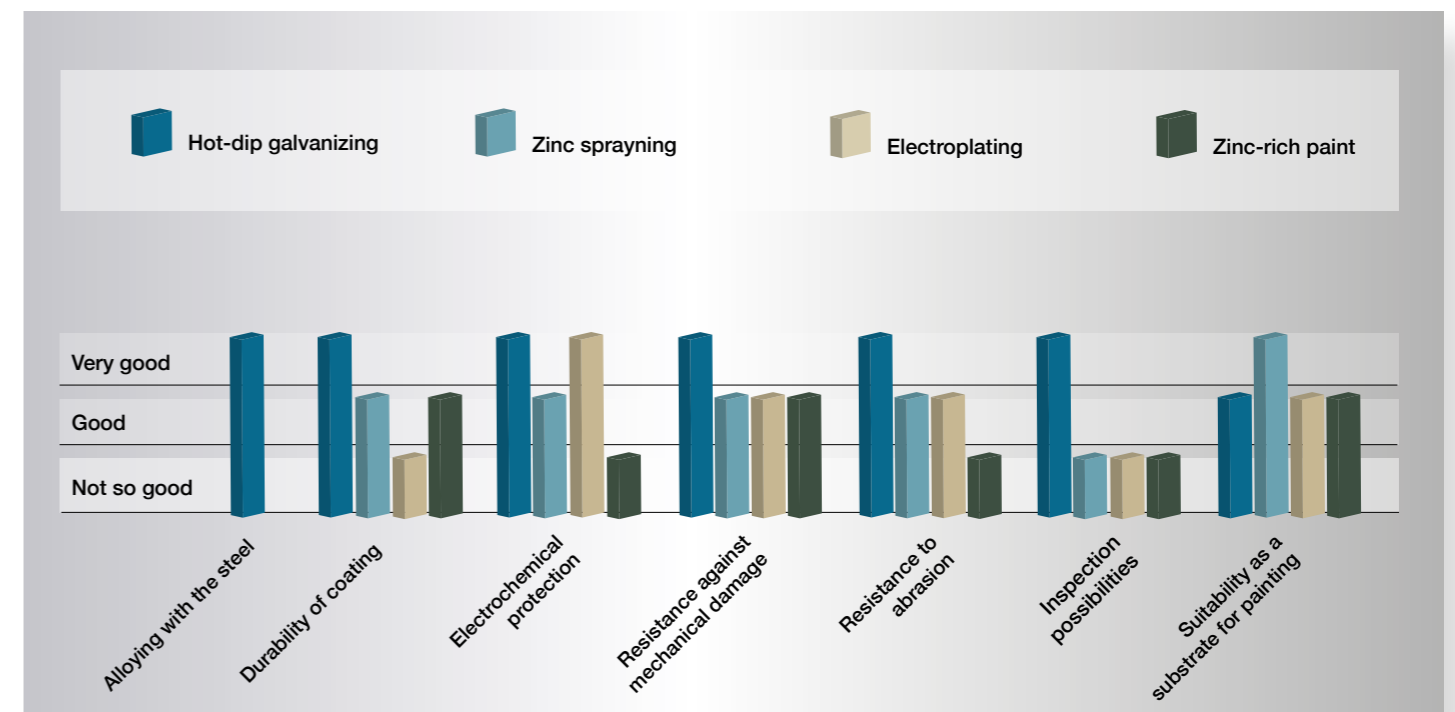

Fig. 3-5. Comparison of the properties of zinc coatings and zinc-rich paint. The properties of mechanically plated coatings will be similar to electroplating.

4. Hot-dip galvanizing

As long ago as 1741, the French chemist, Melouin, discovered that zinc was capable of protecting steel from corrosion. However, the method was not used industrially until another Frenchman, Sorel, introduced pickling with sulphuric acid as a pre-treatment step. He subsequently applied for his first patent on hot-dip galvanizing on 10th May 1837. The main part of the process that Sorel sought to patent is still used today.

In an appendix to his patent application in July 1837, Sorel called the method “galvanizing”, referring to the galvanic cell that is created if the zinc coating is damaged. The steel in the damaged area becomes a cathode in the cell and is protected from corrosion. The name has subsequently been adopted by other methods for coating steel with zinc and is sometimes used for electrolytic metal deposition in general. To avoid confusion, hot-dipping in zinc should be referred to as hot-dip galvanizing (Fig. 4-1).



Fig. 4-1. Hot dip galvanizing.

4.1 The advantages and limitations

The principal advantages of hot-dip galvanizing are:

- a) Low initial cost.
- b) Long service life that very often gives maintenance-free protection against corrosion throughout the entire service life of the structure.
- c) Coating is carried out in fixed installations, according to a defined system. This gives a high reliability of application.
- d) The quality of zinc coating is completely independent of the weather conditions prevailing during the process.

- e) Uniform coatings are applied, even on surfaces that are difficult to access.
- f) Equally thick, or often thicker, coatings are achieved at sharp edges and corners as on flat surfaces.
- g) The ability to withstand mechanical damage during transportation, unloading and erection. Damage during such handling is rare, which means that the coating seldom needs to be repaired on site.
- h) If damage does occur in the form of small scratches and holes, the zinc coating cathodically protects the steel from rust.
- i) Hot-dip galvanized steel can be welded using all the usual welding methods.
- j) Quick and simple inspection.

Limitations with the galvanizing process:

- a) Can only be done in permanent installations.
- b) The colour of the zinc coating can be changed only by painting or powder coating.
- c) The dimensions of the component or structure are limited by the size of the zinc bath.
- d) There is some risk that larger flat sheet surfaces and long, slender beams will warp, due to the effects of heat in the zinc bath.
- e) The welding of zinc-coated steel can demand a somewhat different procedure compared to uncoated steel.

4.2 Process

If the steel surfaces are contaminated with marking paint or welding slag, these must first be removed by mechanical means, such as abrasive blasting or grinding. Moulding sand on the surfaces of castings is removed by blasting with steel shot.

Grease and oil is usually removed in an alkaline degreasing solution. After washing in water, rust and mill scale are removed from the steel surfaces by pickling in diluted hydrochloric or sulphuric acid. Hydrochloric acid is the most commonly used. Pretreatment with bacteria could also be used for degreasing and this has some environmental advantages. This innovation makes it possible to omit rinsing in water after degreasing and go directly into the pickling bath. However, the most common pickling step uses hydrochloric acid (approximately 10-12 %) or iron chloride (5 % hydrochloric acid and about 170 kilo gram iron chloride).

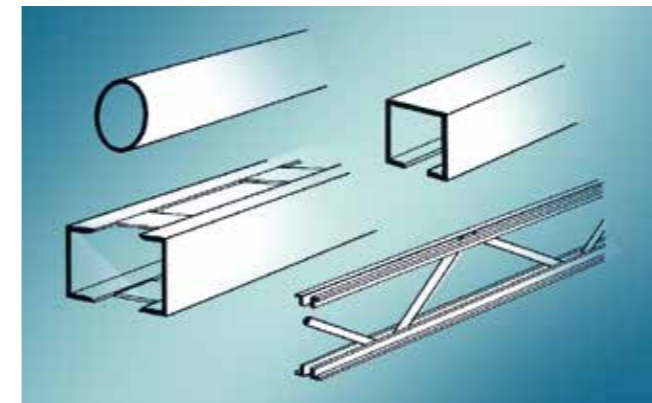

Fig. 4-2. Examples of profiles and structures that are difficult to access for mechanical cleaning. In hot-dip galvanizing, all surfaces receive equally good coatings.

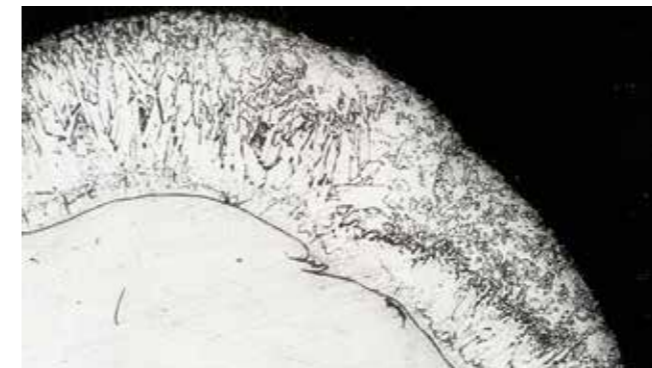

Fig. 4-3. Cross-section through the top of the thread on a hot-dip galvanized bolt. (5 min. 460 °C) Note that the coating on the top of the thread is somewhat thicker than on the flank.

When dipping into the molten zinc, a fluxing agent must be used. The purpose of the fluxing agent is to dissolve oxides on both the steel and the zinc surfaces to enable steel and zinc to make pure metallic contact with each other. The fluxing agent can be added in two different ways, termed “wet galvanizing” and “dry galvanizing”.

a) Dry galvanizing (Fig. 4-5)

In dry galvanizing, the steel components are first degreased, pickled and then rinsed with water. They are then dipped in a flux solution of aqueous zinc-ammonium chloride and dried. By continuous cleaning of the flux bath its iron content is kept below 1 kilogram per litre, which decreases the dross formation in the zinc bath. A thin layer of flux salts remains on the surfaces of the components. Dipping in molten zinc can therefore take place without further addition of fluxing agent. Before the components are dipped into and withdrawn from the bath, the surface of the molten zinc is skimmed to remove oxides and flux residue. After withdrawal from the zinc bath, the components are cooled in water or air. They are then ready for fettling, inspection and dispatch.

b) Wet galvanizing (Fig. 4-6)

In wet galvanizing the surface of the zinc bath is divided into two sections by a cross beam. The fluxing agent — ammonium chloride — is deposited on the zinc surface in one section of the bath. The flux melts in the heat of the bath. The steel components, still wet from pickling, are immersed through the molten flux into the zinc bath. The components are then moved to the flux-free section of the zinc bath. The flux residue and oxides are skimmed from the surface of the bath, whereupon the components can be lifted up through a pure zinc surface. After withdrawal from the zinc bath, the components are cooled in water or air. They are then ready for fettling, inspection and dispatch.

As far as quality and rust prevention are concerned, both methods give equally good coatings. However, the dry method has become more common, as it is easier to use in enclosed installations.

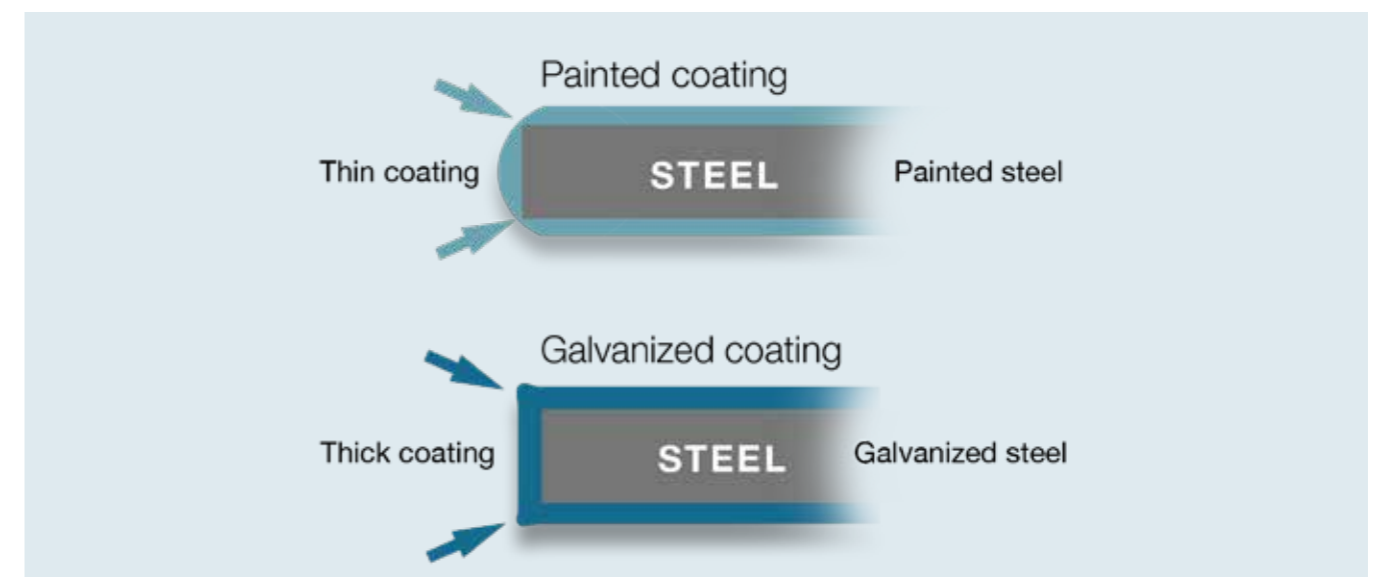

Fig. 4-4. Paint coatings are usually thinner over corners and sharp edges. Hot-dip galvanized coatings, on the other hand, are thicker in these areas.

Dry galvanizing

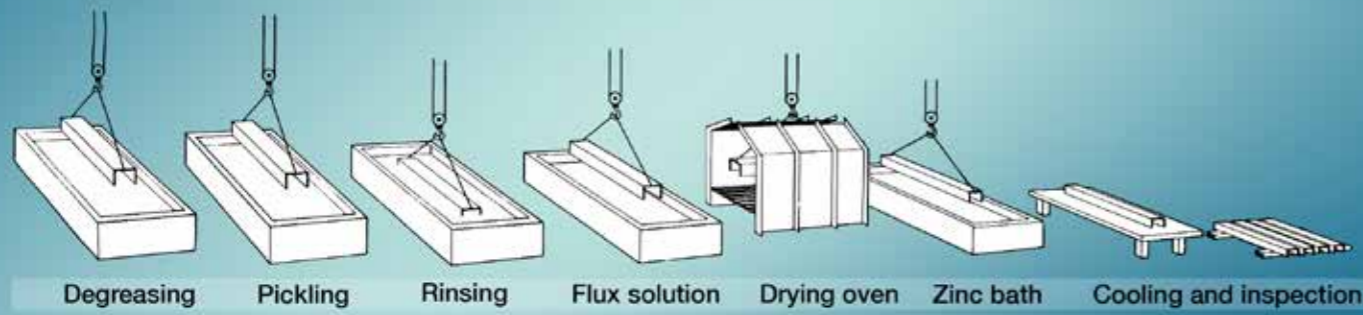

Fig. 4-5. The principle of hot-dip galvanizing by the dry method. Rinsing of the steel between degreasing and pickling may occur.

Wet galvanizing

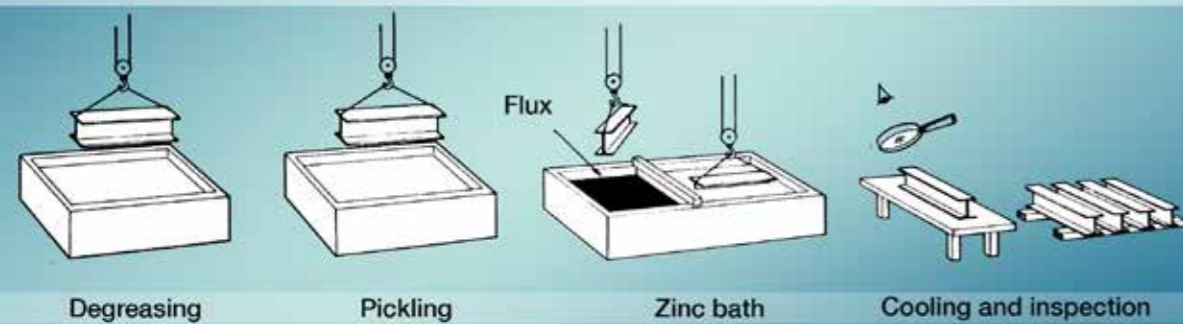

Fig. 4-6. The principle of hot-dip galvanizing by the dry method. Rinsing of the steel between degreasing and pickling may occur.

4.2.1 Hot-dip galvanizing of small components — centrifuging (Fig. 4-7)

Small components such as nails, nuts, bolts, washers and fittings are cleaned as described above and placed in perforated baskets, which are then dipped into the molten zinc. Upon withdrawal from the zinc bath, the basket is placed in a centrifuge, see fig. 4-7. Rotation has the effect of throwing some of the zinc off the coated surfaces, leaving the components free from frozen zinc droplets and uneven deposits of zinc. As a result, the zinc layer is somewhat thinner, with a more matt appearance, compared with individual dipping (which would in any case be far too expensive for small objects). Individual dipping also makes it difficult to obtain even deposits of zinc on certain sensitive areas, such as threads. Dipping of small components is normally performed at high temperature (540-560 °C) and the coating is thinner and has a darker surface compared to coatings

obtained with the low temperature galvanizing (450-460 °C) used for larger articles.

4.2.2 Wire and tube galvanizing

Steel wire, strip and tubes are hot-dip galvanized using either the dry or wet methods — or a combination of both — in continuously operated production lines. Immediately after withdrawal from the zinc bath excess zinc is wiped from wire (or blown off tubes) to give a smooth and uniform coating. The thickness of the zinc coating can be varied to some extent during the wiping or air blowing procedures.

4.2.3 Sheet galvanizing

Steel sheet is hot-dip galvanized in continuous production lines in which all the processes are linked together. The base material consists of cold-rolled sheet in coils. One coil is welded to another to form a continuous strip, fig. 4-8.

Centrifuge galvanizing

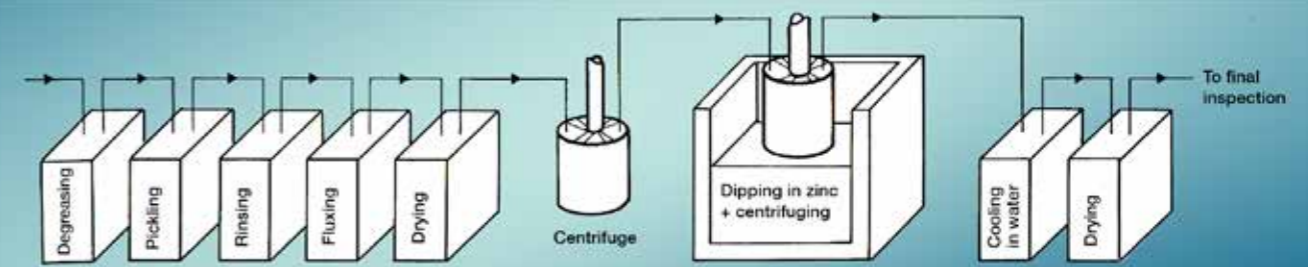

Fig. 4-7. The principle of centrifuge galvanizing. Rinsing of the steel between degreasing and pickling may occur.

After degreasing, the strip is pickled or oxidized. Oxides are then removed from the surfaces by reduction at 950 °C. At the same time the strip is soft-annealed. The surfaces of the strip, now chemically clean, are moved through a protective gas atmosphere and directly into the zinc bath. The dipping time is short, after a few seconds the strip is withdrawn from the bath vertically and passed through “air knives”. Fine jets of air or steam are blown through the knives, wiping the zinc coating to the desired thickness.

Control over the knives and the thickness of the coating is achieved with the aid of thickness gauges and computer control. After cooling, straightening and treatment against wet storage stain, the strip is cut into suitably sized sheets or rolled into coils for delivery or subsequent

ent plastic-coating, painting and/or profiling.

Thin sheet is galvanized with micro alloyed, low-alloyed or high-alloyed zinc. The most important alloy additive is in all cases aluminium. Typical contents for the aluminium additions are 0.2% for micro alloyed, 5% for low-alloyed and 55% for high-alloyed. There are many trade names for these products, such as Galfan for the low-alloy type, and Aluzink or Galvalume for the high-alloy type.

Thin strips can be galvanized in the same way as sheets.

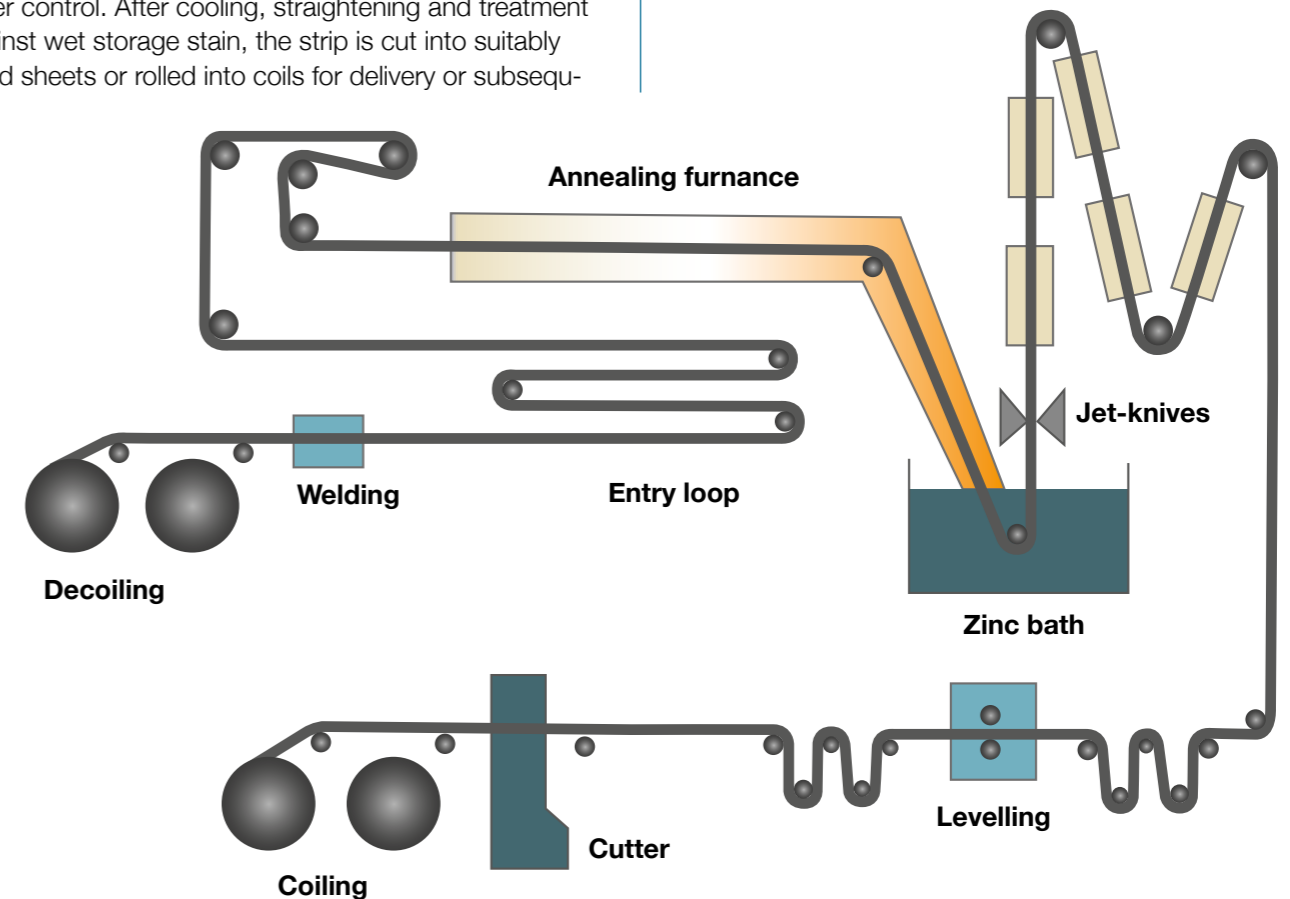

Fig. 4-8. Schematic diagram of installation for hot-dip galvanizing of wide strip (thin sheet).

5. The reactions between iron and zinc

5.1 The structure of the layer

The temperature of the molten zinc in normal hot-dip galvanizing is around 460 °C. When galvanizing small objects such as fittings, nuts, bolts and washers, temperatures around 550-560 °C are used, partly to facilitate centrifuging. At lower temperatures the zinc kettle can be of steel, but a ceramic lining is needed for temperatures above 470 °C.

When steel comes into contact with molten zinc there is a reaction between the metals which produces an iron-zinc alloy on the steel surface. The alloy is made up of different iron-zinc layers, with the iron content decreasing outwards, towards the surface. Upon withdrawal from the zinc bath, a layer of pure zinc adheres to the outermost alloy layer. Fig. 5-1 shows a schematic representation of the structure of such a coating.

The thickness of the coating and the appearance of the surface are determined by the way in which the reaction takes place and how the outermost zinc layer solidifies. The reaction sequence varies according to a large number of parameters. Of these the composition of the steel is of great importance, as are the condition of the steel surface (structure, grain size, stresses, smoothness), the composition and temperature of the molten zinc, dipping time etc. All of these factors affect the process to varying degrees. The mechanism is complicated and is still not fully understood.

During steel production, silicon or aluminum is added to remove oxygen. These steels are known as “killed steels”. Steel may also be produced without these additions and are then called “rimmed steels”. The

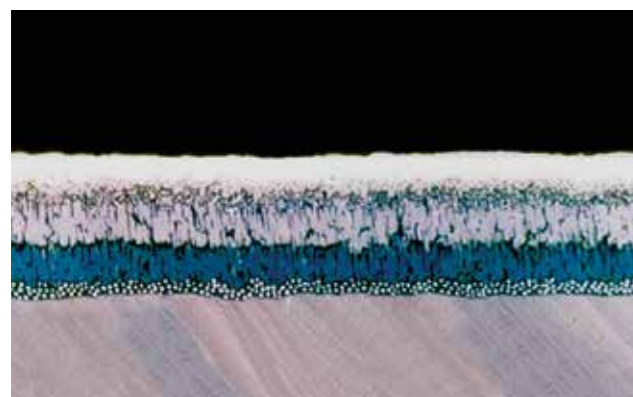

Fig. 5-1. Cross-section of the zinc layer formed by hot-dip galvanizing. Eta layer with 0.03% Fe; Zeta layer with 5.8—6.7% Fe; Delta layer with 7—11.5% Fe; Gamma layer with 21—28% Fe.

content of silicon (Si), and in some cases also phosphorous (P), are of high importance for the hot dip galvanizing reaction, see chapter 5.2.

5.2 Aluminium-killed steels

This group of steel has a silicon+phosphorous content below 0.03 %. When rimmed and aluminium-killed steels are hot dip galvanized the iron-zinc crystals in the alloy layer are packed tightly together. (Fig. 5-2). The molten zinc is therefore prevented from reaching the steel surface. As a result, the reaction takes place solely by the diffusion of iron and zinc through the alloy layer. This causes the speed of the reaction and the coating growth rate to diminish, which gives a relatively thin coating.

When the zinc in the outermost layer solidifies, the surface becomes smooth and takes on a slightly bluish metallic lustre (see fig. 5-7). In some cases, especially that of thin sheet, the zinc can solidify in the form of randomly pointed crystals, which gives the surface a distinct “spangle” finish. Additions of bismuth, lead or tin will strengthen the spangle finish in hot dip galvanizing.

The spangle finish is just a particular form of crystal formation, which depends on factors like the solidification rate, but gives no indication of the quality of hot-dip galvanizing. Furthermore, the spangle finish is of no significance to the corrosion resistance of the coating.

In continuous hot-dip galvanizing of steel sheet, the size of the spangles can be controlled. This is not possible in the galvanizing of individual objects or structures.

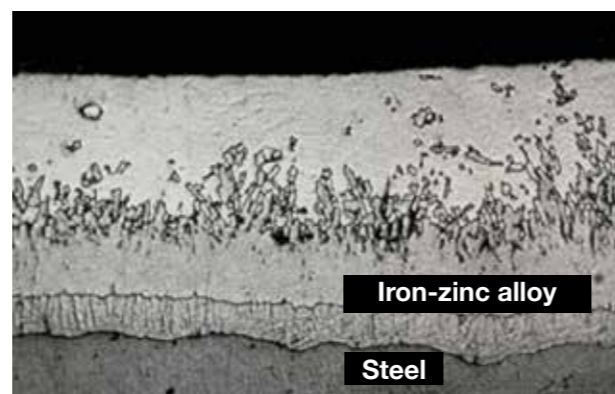

Fig 5-2. Cross-section through zinc coating on rimming steel. On aluminium-killed steel the coating has similar composition.

5.3 Steels in “ Sandelin range”

Semi-killed steels with a silicon + phosphorous content in the range 0.03-0.14 weight percent are called “Sandelin steels” in galvanizing terminology. These steels should either be avoided or special types of galvanizing baths should be used for galvanizing them. In a conventional zinc bath the reaction between this type of steel and zinc is very strong and the coating becomes thick and irregular, often with poor adherence. It is the crystals in the outermost alloy layer, the zeta-phase, that grow as small, thin grains. Molten zinc diffuses rapidly between the grains and the growth of the coating is very fast, fig 5-3, 5-5 and 5-6. If zinc baths with suitable alloy additions are not available, see chapter 5.5, this type of steel should be avoided for hot-dip galvanizing.



Fig 5-3. Cross-section through zinc coating on a steel in the Sandelin range, with 0.06% Si. Galvanizing carried out at 460 °C.

5.4 Silicon-killed steels

Silicon-killed steels have a silicon content higher than 0.14%. The zeta phase grows as larger crystals, see fig. 5-4. The structure has loose packing between

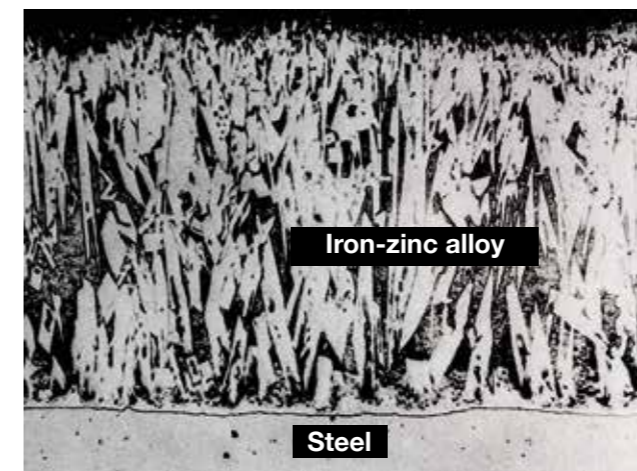

Fig. 5-4. Cross-section of a coating on a silicon-killed steel with 0.26% Si, 460 °C.

the alloy crystals and zinc from the bath is therefore able to penetrate nearly all the way down to the steel surface. The reaction is not retarded, but remains rapid throughout the period during which the object is immersed in the zinc. The thickness of the coating therefore increases considerably with increased immersion time (fig. 5-6) and the coating generally becomes relatively thick. Unlike for Sandelin steels, the growth is controlled and the coatings are of good quality.

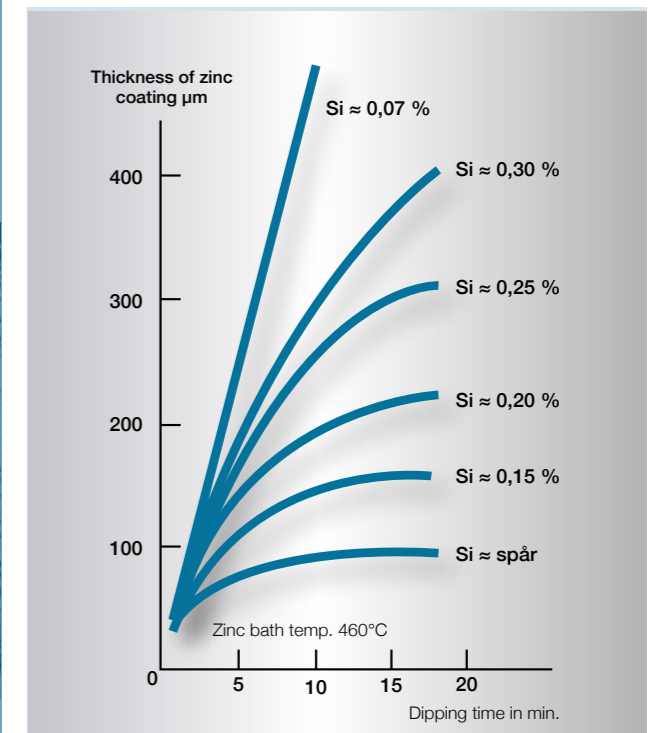

Fig 5-5. Relationship between dipping time and thickness of zinc coating in steels with different silicon contents. The curves are average curves, based on experiments and practical experience. Significant variations can occur between steels with the same silicon contents, but from different charges.

It should be noted that the loose packing of the alloy crystals described above does not mean that the coating will be “porous”, or full of cavities. The space between the alloy crystals is always filled with pure zinc. With silicon-killed steels, therefore, the same compact metallic coating is obtained throughout as with rimmed or aluminium-killed steels.

However, the influence of silicon does not increase linearly with increasing concentration, but follows the curves shown in fig. 5-5 and fig 5-6, which gives mean values and does not show variations between different steels with the same silicon content from different heats. Variations can also occur between different heats of the same steel and even within the

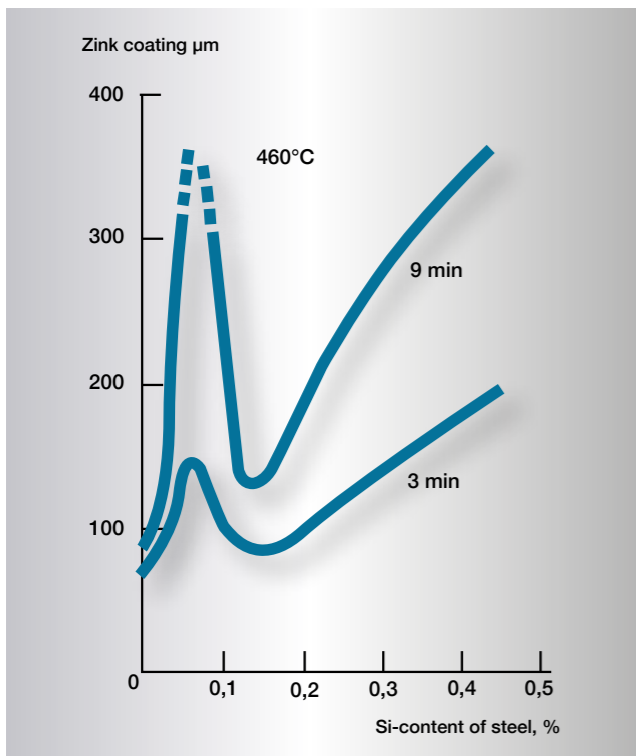

Fig 5-6. Relationship between silicon content of steel and thickness of zinc coating for dipping times of 3 and 9 minutes respectively at 460 °C.



Fig. 5-7. Hot-dip galvanized tubes with different silicon content. Some of the tubes consists of aluminium-killed steel and have a shiny coating, while others consist of silicon-killed steel which gives a dull, grey coating.

same heat. The variations are thought to occur as a result of different quantities of “available” silicon binding with oxygen, in spite of the different steels containing the same total amount of silicon. Greater or lesser amounts of free silicon are therefore dissolved in the steel, and it is only these amounts that influence the reaction (7). It has also been proved (8) that silicon can be distributed unevenly in the surface layer of the steel. This also applies to a number of other elements, such as sulphur and phosphorus, which can also influ-

ence the course of the iron-zinc reaction (9).

Upon withdrawal of the object from the zinc bath, a layer of zinc adheres to the alloy layer, even on silicon-killed steels. However, the reaction speed in these steels can be so high that the pure zinc layer is transformed completely to iron-zinc alloy before the hot object has had time to cool down. The reaction does not cease until the temperature of the object has dropped below approx. 300 °C.

The iron-zinc alloy formation can therefore extend to the surface of the coating, which would then be matt, rough and light to dark grey in colour (fig. 5-7). The colour is determined by the proportion of iron-zinc crystals that are mixed with pure zinc on the outer surface of the coating — the more pure zinc, the lighter the surface; the higher the iron-zinc content, the darker the surface.

Often, the surface is not uniformly grey, but has a blotchy appearance with a mixture of matt, grey and shiny areas. The reasons for this can be many - the concentration of silicon (primarily), phosphorous and sulphur or other elements in the steel surface; stresses in the steel surface; the heat treatment and structure of the steel - all such factors influence the reactions sequence.

Even the cooling process of the steel after galvanizing influences its appearance. The surface uniformity of the steel, especially in cold formed material, also plays a part in the growth of the zinc coating. The coarseness of the surface should not be too great, but nor should it be too smooth. Zeta crystals have a tendency to grow out at right angles from the steel surface.

Thus, on convex and to some extent flat surfaces the crystals can grow without disturbing each other and the molten zinc can easily penetrate between the crystals, which increases growth.

On concave surfaces, dips and depressions, however, the crystals block each other and limit the growth.

5.5 Influence of alloying elements in the steel

Carbon at levels below 0.3% has little influence on the iron-zinc reaction, but higher levels increase the speed of the reaction and consequently the thickness of the coating. The form in which the carbon exists in the steel, e.g. as pearlite, sorbite, martensite etc. (10) is also of significance.

Manganese, chrome and nickel also accelerate the reaction, but not significantly at the concentrations usual in low-alloyed steels (11).

Niobium, titanium, and vanadium are used as grain-refiners in steel. Their concentrations are normally so low in the steels in question that their influence is negligible (12).

Sulphur and phosphorus levels are normally low in structural steel and seldom have much influence on the reaction between zinc and iron. An exception for phosphorous is when the silicon and phosphorous content together reaches 0.03 weight percent. In this case, the steel composition enters the Sandelin range and is very reactive, see chapter 5.3.

Higher sulphur levels — above approx. 0.18 % — like those in certain free cutting steels, can accelerate the reaction to such an extent that the steel cannot be hot-dip galvanized. The attack from the zinc would be so vigorous that the steel would be ruined.

5.6 Influence of other factors

The temperature in the zinc bath is normally around 460 °C. Within the practical range of 440—470 °C the speed of the iron-zinc reaction does not change noticeably.

If hot-dip galvanizing takes place at 550— 560 °C, the outermost layer (the zeta phase) does not form in the alloy layer. The coating will under these circumstances consist of a mixture of delta-crystals and zinc. The surface would normally be matt, and dark or light grey in color.

Since the zeta-layer does not form when hot-dip galvanizing at high temperatures the influence of silicon on the reaction between iron and zinc is eliminated. Different types of steel react in roughly the same way, and the resultant coatings are of the same thickness, regardless of the type of steel. Coating thicknesses above approx. 100 μm cannot be obtained.

The immersion time in the zinc bath is determined mainly by the shape and thickness of the object being dipped. It is normally between 1.5 and 5.0 minutes. However, objects that are difficult to handle can have immersion times as high as 10 minutes. The variation of the thickness of the coating with different steel types is shown in fig. 5-5.

Varying surface roughness of the steel leads to variations in thickness of the coating. The rougher the surface of the steel, the thicker the coating. Depending on the type of steel and the surface profile, preparation treatment such as shot blasting can give a 15 – 100 % thicker coating. Steel that has been severely attacked by rust, or pickled without inhibitors, also gives increased thickness to the coating.

Different machining operations such as turning (in which high feed gives a thicker coating and low feed gives a thinner coating), grinding and flame-cutting can sometimes produce slightly unexpected effects in the formation of the zinc coating.

The thickness of the steel stock influences the thickness of the zinc coating — the thinner the steel

gauge, the thinner the coating. This applies especially to silicon-killed steels that are below 5 mm in gauge. One reason for this is that lighter objects receive shorter immersion times than heavier objects. The working (rolling) and heat treatment of the steel can also be different for different dimensions. This gives different structures that react differently in the zinc bath.

The composition of the zinc bath can only be varied to a minor extent in ordinary hot-dip galvanizing. The melt is electrolytically-refined zinc (often SHG – special high grade) with a purity of 99.995% Zn. The rest is mainly iron. To optimise the galvanizing process, some alloying elements may be added.

5.7 Influence of alloying elements in the zinc melt

In recent years intensive research has been conducted on the use of zinc alloys. It has primarily dealt with aluminum or other additives, with a view to avoiding the powerful influence of the Sandelin effect, get a shinier coating, better drainage of excess zinc or to increase the corrosion resistance of the zinc coating. Aluminium in low concentrations (0.001 to 0.01%) is added to give a shinier appearance. Higher concentrations give dark, uncoated spots on the surface of the coating. The reason for that is that the flux used in hot dip galvanizing is not able to accommodate

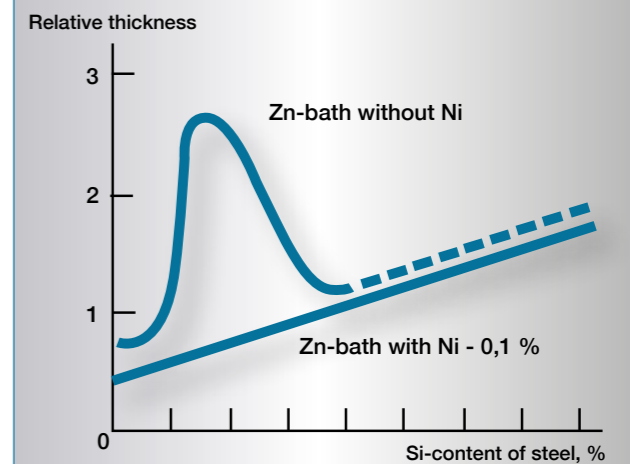

Fig 5-8. Relationship between the silicon content of steel and thickness of zinc coating when galvanizing in alloyed zinc (0,1 % Ni).

the aluminum oxide. Higher aluminum contents are possible to use in continuous galvanizing processes for strip and wire (0.1-5 %). For thin sheet steel aluminum contents up to 55 % may be used.

Nickel additives (0.05-0.07 %) eliminate a large part of the Sandelin effect and give more consistent growth with increasing silicon levels in the steel. With

silicon contents above 0.22%, nickel has no effect on the thickness of the coating. When galvanizing silicon-killed steels in nickel-alloyed baths, the Sandelin curve therefore appears as shown in fig. 5-8. Since the presence of nickel decreases the growth of the zeta phase, the pure zinc layer in the outermost part of the coating get thicker and the appearance is shinier. In some cases nickel is used in combination with bismuth.

5.8 Choice of steel

Since the type of steel, primarily the silicon content, has a large influence on the coating thickness in hot-dip galvanizing it is very important that the constructor or manufacturer are well aware of this in order to get the right result in every individual case.

5.8.1 Aluminium killed steel with lower reactivity than expected

Aluminium killed steels also contain low levels of silicon, which is important for the reactivity. In recent years aluminium killed steel with so-called ultra-low silicon content, below 0.01%, and aluminium content above 0.035% has become more common. These steels have many positive properties when it comes to cutting and formability, however the low silicon content in combination with the high aluminium content makes the zinc layers thinner than stated in the hot dip galvanizing standard EN ISO 1461.

If the galvanizing is performed in a nickel alloy bath, which is common today since nickel is considered to add several positive properties, the reactivity is further decreased, with thinner layers as a result. A deviation from the standard for such steels can be agreed between customer and galvanizer. If a deviation cannot be accepted, this type of steel must be blasted before galvanizing.

5.8.2 Risk of Sandelin Effect

As described in chapter 5.2, it is important that the silicon + phosphorus content in the Aluminium killed steels is kept below 0.03 % if a layer of good quality should be formed. Research studies have shown that cold and hot rolled steel can behave somewhat differently in hot dip galvanizing, which is discussed below. When the finnish requirements on the galvanized surface are "normal", an aluminium killed steel with silicon + phosphorus content < 0.03 % is adequate and gives acceptable surface finish on both cold and hot rolled steel.

If the appearance of the galvanized surface is of high importance, for example in architectural applications, the following expression shall be used for cold rolled steel:

$Si < 0.03$ and $Si + 2.5 \times P < 0.04$ weight percent

For hot rolled steel the silicon content is even more critical, but the phosphorus content is of less importance, and the following expression could be used (28,29):

$Si < 0.02$ and $Si + 2.5 \times P < 0.09$ weight percent

5.8.3 Higher coating thicknesses

If the hot-dip galvanized steel should be used in a more corrosive environment the Swedish appendix to EN ISO 1461 gives advice and instructions. The suggested silicon content is then > 0.22%, and the coating thickness increases with increasing silicon content, fig. 5-5. If the corrosion environment is extreme, thick coatings should be used, or galvanizing in combination with paint, see chapter 11. If the user wants a smooth and shiny appearance of the coating an aluminum-killed steel should be used.

5.9 The iron-zinc reaction in strip galvanizing

In continuous hot-dip galvanizing of sheet, the stock material consists of cold-rolled steel strip of a composition suited to the method. The immersion time is very short, and the temperature is kept within narrow limits. The zinc bath is alloyed with a small amount of aluminium (approx. 0.2%), which has the effect of retarding the iron-zinc reaction in short immersion times. The alloy layer will be thin, approx. 1-2 µm, with the remainder of the coating, from 7 to 30 µm, consisting of pure zinc (fig. 5-9).

The iron-zinc alloys are relatively hard and brittle. However, since they have to a large extent been replaced by soft zinc, continuously hot-dip galvanized sheet can be bent, curved, folded, press-formed and even deep-drawn without the coating cracking or flaking off. As mentioned in chapter 5.5 thin sheet can even be coated with aluminium-alloyed zinc, which gives some what better protection against corrosion in severe environments. Some common brand names include Galfan (5% aluminum), and Aluzink or Galvalume (55% aluminum).

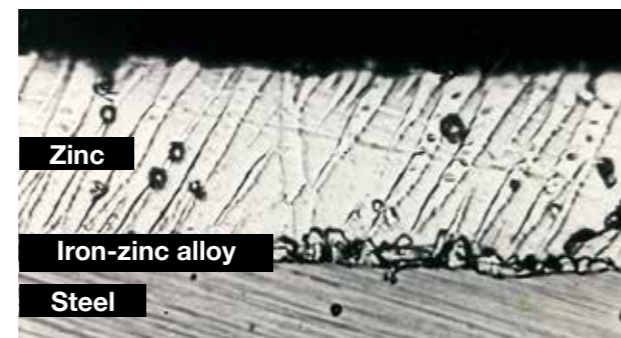

Fig. 5-9. Cross section through zinc coating on continuously galvanized thin sheet.

6. The strength of hot-dip galvanized steel

6.1 Tensile strength, notch toughness and ductility

A very large number of experiments and tests have been conducted over the years in order to ascertain whether, and to what extent, hot-dip galvanizing affects the mechanical properties of low-carbon, un-alloyed and low-alloyed steels. The test results are briefly summarized below and apply both to steel galvanized at the usual (460 °C) and high (560 °C) temperatures.

The ultimate tensile strength, yield strength, elongation at rupture point and contraction of hot-dip galvanized steel remains virtually unchanged after hot-dip galvanizing in both the welded and un-welded states.

The strength of cold-worked or heat-treated steel can be reduced during hot-dip galvanizing. The extent of the reduction depends on the degree of working or on the nature of the heat treatment.

The notch toughness of hot-dip galvanized steel reduces somewhat compared with artificially aged specimens, but not enough to affect the use of the steel.

The ductility of steel is not affected by hot-dip galvanizing. Excessive bending can however lead to cracking in the zinc coating itself.

6.2 Weld stresses

In welded structures, weld stresses are partly reduced by hot-dip galvanizing. Hardening stresses in the zones affected by the heat of the weld are also reduced. This means that welded structures have a higher static strength in the hot-dip galvanized form than in the untreated condition.

6.3 Fatigue strength

The fatigue strength is affected differently by hot-dip galvanizing depending on steel type. There is a relatively small reduction in aluminium-killed steels, while the reduction in silicon-killed steels can be a little bit higher. The reason for this is the differing composition of the iron-zinc layer. Under fatigue conditions cracks form in this layer which may then act as initiators for cracking in the steel surface.

In the determination of fatigue data in laboratory experiments, however, hot-dip galvanized material is compared with "new", untreated steel. But if an

untreated structure is exposed outdoors, it is immediately attacked by corrosion. Pits form that are 5–7 times deeper than the general corrosion, and the fatigue strength sinks rapidly. The same applies to a painted structure when there is damage to the paint film, which results in rust attack in the damaged area.

Conversely, the fatigue strength of hot-dip galvanized steel does not change appreciably during the exposure time, provided that the zinc coating remains on the steel surface. Under normal conditions, pitting does not occur in the zinc coating. The reduction in fatigue strength caused by hot dip galvanizing is small compared with the reduction caused by corrosion attack (fig. 6-1). It should be noted that abrasive blasting and, more especially, welding also reduce fatigue strength.

6.4 Brittleness and cracking

Cold-working reduces the notch toughness of steel and raises the transition temperature for brittle fracture. Subsequent ageing at raised temperatures strengthens this effect. Even if the steel itself is age-hardened, the effect of cold-working can be sufficient to cause the steel to have inadequate toughness to meet the applicable demands. The ageing process may in certain cases be accelerated at the elevated temperature of the galvanizing bath. However, these steels eventually become brittle whether they are hot-dip galvanized or not.

In hot-dip galvanizing, it is important to know whether or not the components have been cold-worked. Both aluminium-killed and silicon-killed steel could be affected negatively by cold deformation and ageing through galvanizing.

If cold working of a susceptible steel cannot be avoided the steel should be stress relieved at 600-650 °C for 30 minutes or normalized prior to galvanizing. However, susceptible steels are relatively uncommon.

Hot-dip galvanizing of ordinary unalloyed or low-alloyed structural steel will not give rise to hydrogen embrittlement. Hydrogen, which may be absorbed during pickling, will mostly be thermally expelled upon immersion in the zinc. Absorption of hydrogen may, however, lead to embrittlement of some hardened

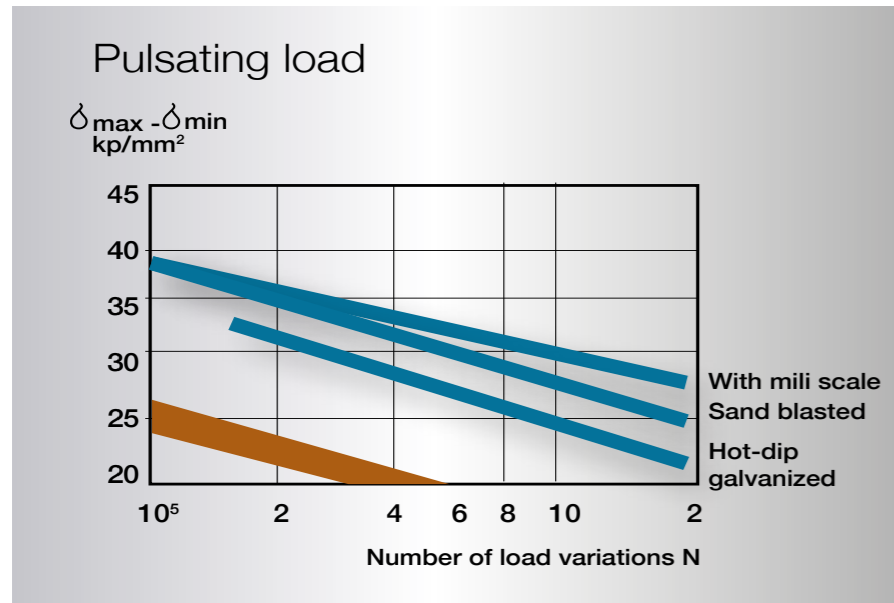

Fig 6.1. Whöler curves for steel S355, pulsating load. The brown band indicates the sequence during normal corrosion fatigue.

or high strength steels. Trials should be carried out before large batches of such steels are galvanized. Blasting instead of pickling is a possibility to avoid the problem.

Intercrystalline cracking can in certain cases occur in hot-dip galvanizing due to the penetration of zinc into the intergranular boundaries of steel. A precondition for this is that large stresses have been induced through welding or hardening of the steel. The risk of intercrystalline cracking or fracture due to zinc penetration is negligible in the hot-dip galvanizing of ordinary structural steel. However, hardened material can be sensitive, and tests should always be carried out on such material before large lots are hot-dip galvanized. The risk of cracking can be minimized if steel is annealed at temperatures higher than those in the zinc bath, i.e. above 460 °C.

6.5 Hot-dip galvanized steel and fire

Hot-dip galvanized steel does not burn, but the strength decreases when the temperature rises. Steel constructions stay stable until the critical temperature is reached. This will occur between 500 and 750 °C depending on the loading situation.

Fire protection should be considered from the beginning of the construction work. It is often possible to reduce both fire risk and costs for protection already on the drawing table.

The fire resistance time is the minimum time in minutes that a construction is stable during a so called "standard fire". The construction is not permitted to collapse during that time. The minimum time is the ground for the classification according to fig. 6-2.

The time to collapse may be extended by the following actions:

- Delay of heat penetration by covering (with concrete or mineral fibre)
- Transformation of heat by for example filling columns with water or concrete

For hot-dip galvanized steel, often the first alternative above is used and the construction is then classed in fire resistance class F 30-60.

In principle the same type of fire resistance classification as for uncoated steel can be used even on hot-dip galvanized steel.

Fire resistant class	Fire resistant time (Minutes)	Symbol in the construction inspection rules
F 30	≥ 30	Fire resistant
F 60	≥ 60	Fire resistant
F 90	≥ 90	Fire proof
F 120	≥ 120	Fire proof
F 180	≥ 180	Very fire proof

Fig. 6-2. Fire resistance classes.

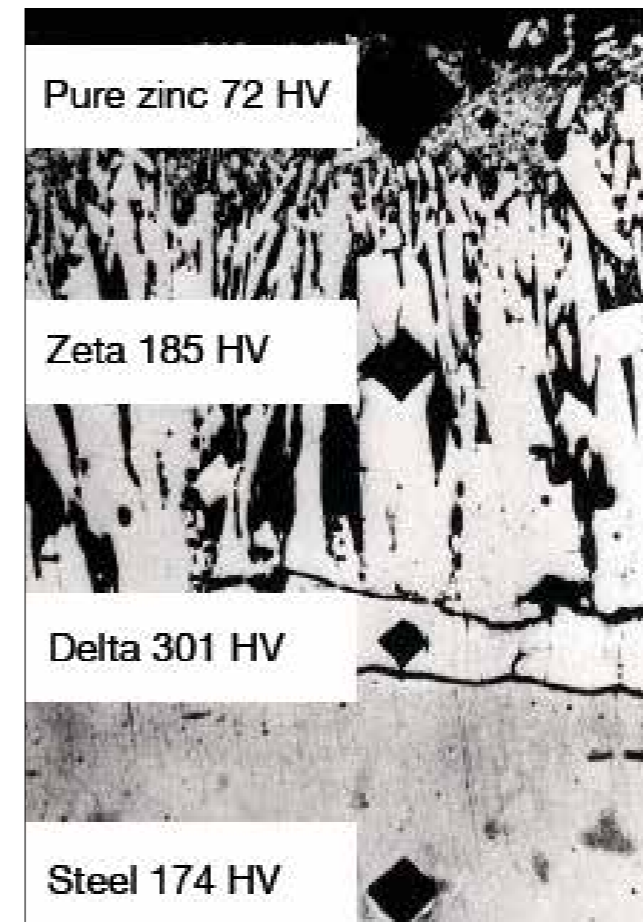

Fig. 6-3. Impressions from microhardness measurements in steel and different phases of the zinc coating.

6.6 Hot-dip galvanized steel exposed to elevated temperatures

A project "Hot dip galvanizing of steels that may cause problems" was performed by Nordic Galvanizers in cooperation with the research institute RISE KIMAB (Stockholm, Sweden) to study how hot-dip galvanized coatings react when exposed to elevated temperatures (13). Earlier results had shown that the coatings could cope with temperatures up to 275 °C, which is true if the exposure time is relatively short. For exposure times longer than a few weeks, this temperature is too high.

Results from the above project have shown that high temperature galvanized coatings (immersion at 560 °C, see 4.2.1) respond worse to elevated temperatures than coatings formed by low temperature galvanizing. The reason is that an elevated temperature causes solid phase transformations in the coating. The outermost pure zinc coating is transformed to an intermetallic iron-zinc phase. When the whole coating consists of this iron-zinc phase, it becomes more brittle and cracks may form, especially during cooling (cyclic processes). High temperature galvanized coatings are especially sensitive since they consist

predominantly of intermetallic phases from the outset.

Combinations of elevated temperatures and mechanical strains, for example vibrations, should be avoided.

Low temperature coatings with a large part of pure zinc have the best possibility to withstand elevated temperatures for longer periods.

This leads to the following recommendations for use of galvanized products at maximum elevated temperatures:

- A) Low temperature galvanized coatings: 225 °C (for shorter times 250 °C may be accepted).
- B) High temperature galvanized coatings: 200 °C

6.7 Durability against wear

Pure zinc is a soft metal, but it is harder than most of the organic coatings on the market. However, the intermetallic iron-zinc phases created during hot-dip galvanizing are very hard, even harder than common construction steels, fig. 6-3. Because of that the iron-zinc phases are more resistant to wear than pure zinc. Studies have shown that the intermetallic layer has a wear resistance that is 4-5 times better than the pure zinc layer (14).

Hot-dip galvanizing is often commonly used on products where the surface is exposed to wear, for example thresholds in vehicles, transportation wagons, steps, handrails and gratings.

7. Design and fabrication of structures

Design of structures to be hot-dip galvanized is no different from that for good structural, surface treatment and welding practice in general. However, certain components require special attention.

- It is important that larger structural components are matched to the size of the pickling tank and zinc bath (Fig. 7-2). Sometimes “double-dipping”, which involves the handling of structural components longer than the zinc bath, is employed. (Fig. 7-3).

- Bolted joints are preferred instead of welding, since welding burns off the galvanized coating, which has to be repaired.

- The weight of the construction. The galvanizing plants can only handle constructions that the cranes can handle.

7.1 Safety requirements

Hot-dip galvanizing involves dipping components and structures in both pretreatment baths and molten



Fig. 7-1. Galvanizing of cable trays. Tilting the goods improves the run off of excess zinc when leaving the bath.

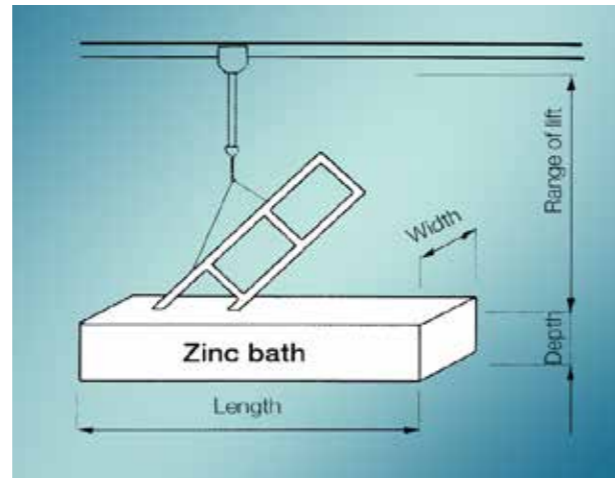

Fig. 7-2. Schematic diagram of hot dip galvanizing.

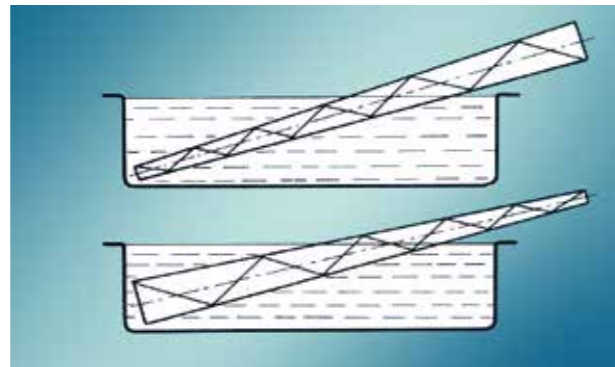

Fig. 7-3. Schematic diagram of double-dipping.

zinc. This means that hollow structures, such as pipes, tubing, and containers and also beam structures, which are welded round the connection point, must be provided with holes for drainage and venting. If a sufficient number of holes is not provided to enable complete venting, there is a significant risk that the structure will explode on immersion.

Also, pickling acid is capable of penetrating pores in welds. Upon dipping in the zinc bath the residual pickling liquid is vaporized and the pressure can be so high that the object explodes. The risk of serious injury to personnel, or damage to materials, is large when such explosions occur.

Suitable dimensions for venting holes are given in fig 7-4. The holes must be located to enable total venting and to enable pickling acid and molten zinc to run in and out easily. Illustrations show this point.

Round profile (mm)	Square Profile (mm)	Rectangular profile (mm)	Diameter venting hole (mm)
20	< 20	30x15	10
30	< 30	40x20	12
40	< 40	50x30	14
50	< 50	60x40	16
60	< 60	80x40	20
80	< 80	100x60	20
100	< 100	120x80	25
120	< 120	160x80	30
160	< 160	200x120	30

Fig. 7-4. Suitable hole sizes for venting of tubular structures.

Examples of the location of the holes are given in the illustrations. It is also advisable to contact the galvanizer to discuss alternative hole sizes and locations. Holes can be formed by drilling, grinding or gas-cutting.

7.2 Quality considerations

The following guidelines are not necessarily preconditions for hot-dip galvanizing but, if they are observed, quality is likely to be considerably better and the galvanizing process easier.

7.2.1 Provision for handling

A structure should preferably be designed with easily handled components, which are assembled after hot-dip galvanizing. Threaded unions are a good means of achieving this. The structure or object should be equipped with lifting holes or lifting eyes, to which lifting gear can be connected. Avoid inward-projecting pipe connecting stubs in containers. Pipe connecting stubs should be located in corners and diagonally, otherwise the container cannot be completely emptied of zinc (Fig. 7-8).

7.2.2 Mobility

Components that are to move on each other should be assembled after hot-dip galvanizing. If this is not

possible, mobility can be retained by giving the components a clearance of 1.0 mm on each side, i.e 2.0 mm larger than the shaft.

7.2.3 Avoid structures that can distort

Materials with excessive variation in sectional thickness should not be combined on the same structure or object (fig. 7-7). Otherwise, heating in the zinc bath would be uneven, and the object could warp. Long, slim structures should be avoided. Large flat sheet surfaces, where the sheet thickness is less than 3 - 4 mm should be stiffened (fig. 7-9), or they might warp.

If possible, structures should be designed so that welding can be performed symmetrically, around an axis of flexure. The welding sequence should be planned so that stresses are as low as possible.

7.2.4 Avoid combining different materials and different surface conditions

Newly rolled steel should not be welded to cast iron, or to steel that has been attacked by deep-seated rust, since the zinc coating will be uneven and the appearances of the surfaces will be different. Such materials must be galvanized in different ways, which is not possible if they have been welded together.

Different types of steel, such as aluminium-killed and silicon-killed steel, should not be welded in same construction. If this is not observed, both the appearance of the surface and the thickness of the zinc coatings will be different (fig. 5-7).

7.2.5 Avoid acid traps

Structures should be designed to avoid narrow crevices or gaps (fig. 7-10 and 7-13). As far as hot-dip galvanizing is concerned, butt welds are better than lap welds. If lap welds must be used, they should be welded around the entire joint. It is important to avoid the formation of pinholes. If the gap between contact surfaces is larger than 100 cm², venting holes must be provided to avoid the risk of explosion (fig. 7-6).

If acid has penetrated a crevice, it cannot be removed later. Since molten zinc is more viscous than acid, it will seal the opening during hot-dip galvanizing. After a while, the acid causes holes in the coating over the opening. A rust-coloured liquid then runs on to the surface and spoils the appearance. Castings should have an even, sealed and sand-free surface. Pores and cavities can act as acid traps and should therefore be avoided.

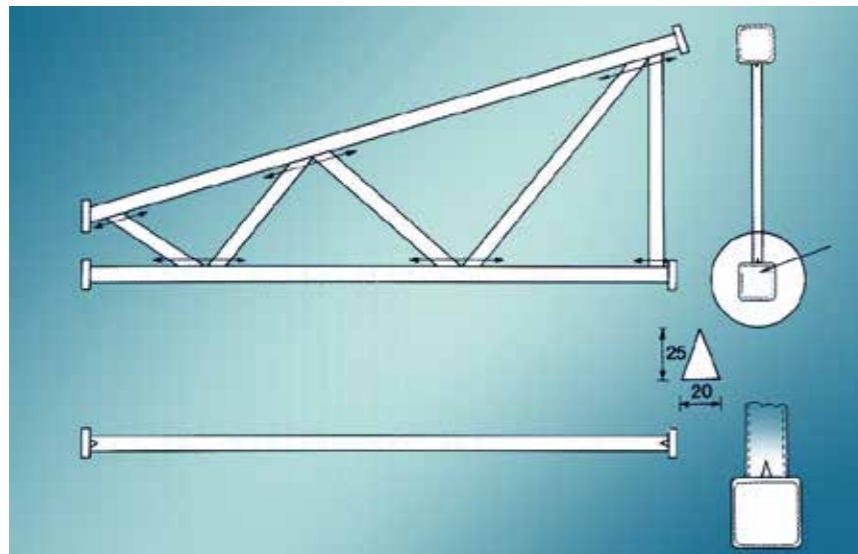

Fig. 7-5. In welded structures venting holes must be inserted at all junctions. The holes must enable the zinc to run in and out freely. Closed tubes incur the risk of explosion!

7.2.6 Overlapping surfaces

In the same way as with internal cavities, (chapter 7.1) overlapping surfaces must be provided with holes for drainage and venting. Insufficient holing may lead to explosion when the construction burst into the hot zinc bath. Instructions on the size and location of the holes is given in table 7.2.

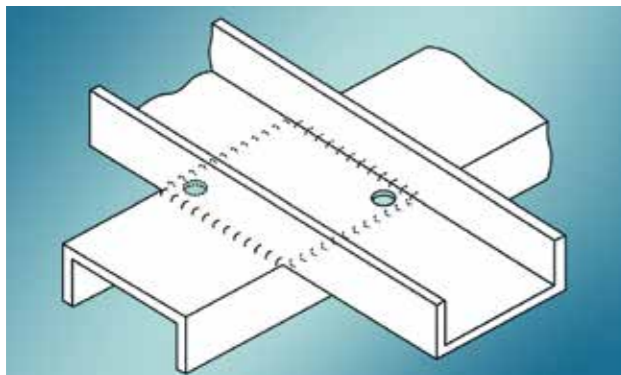
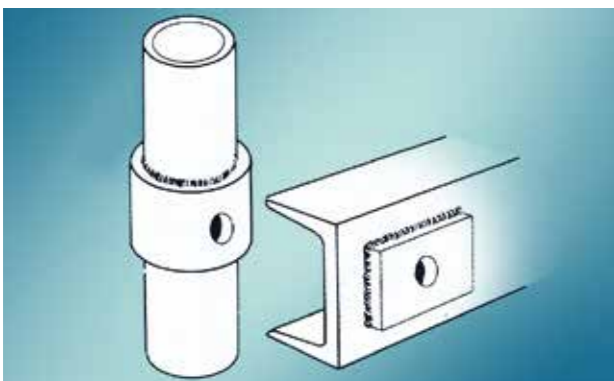

Fig. 7-6. Objects with welded-on reinforcements and lap joints must be provided with holes if the contact area between the pieces is larger than 100 cm². An acid trap is created, but must be accepted, since there is a large risk of explosion if a hole is not made.



Area of overlap	Recommended action
Up to 100 cm ²	Circumferential tight weld. The material should be dry for the welding process and the overlapping parts should be smooth and assembled without gaps.
100 to 1000 cm ²	In diagonally opposite positions: <ul style="list-style-type: none"> • 2 x ≥ 12 mm holes at corners • (Alternative: 2 x ≥ 25 mm intermittence of welds at corners)
1000 to 2500 cm ²	<ul style="list-style-type: none"> • 4 x ≥ 12 mm holes at corners • (Alternative: 4 x ≥ 25 mm intermittence of welds at corners)
≥ 2500 cm ²	In diagonally opposite positions <ul style="list-style-type: none"> • ≥ 12 mm holes at corners and circumferentially at least every 300 mm from the corners • (Alternative: ≥ 25 mm intermittence of weld at corners and circumferentially at least every 300 mm from the corners)

Table 7-2. Recommendations regarding drain holes for overlapping surfaces as well as their size and location according to the standard ISO 14713-2. The holes should be placed in an appropriate way in relation to how the construction will hang during dipping.

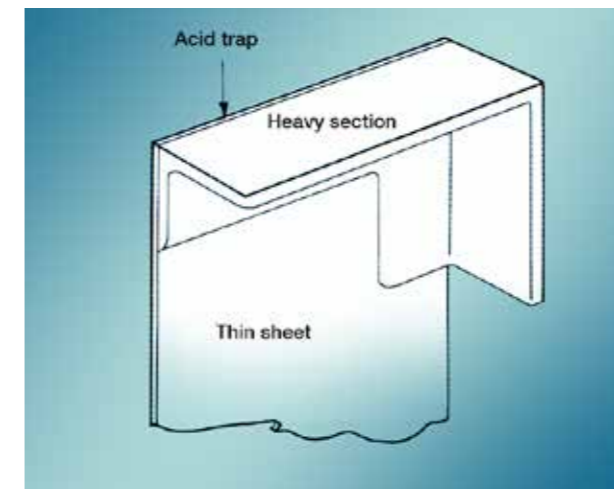

Fig. 7-7. Do not weld parts of widely differing thickness together. The object may be deformed in the zinc bath and during cooling after dipping due to differing heating and cooling rates.

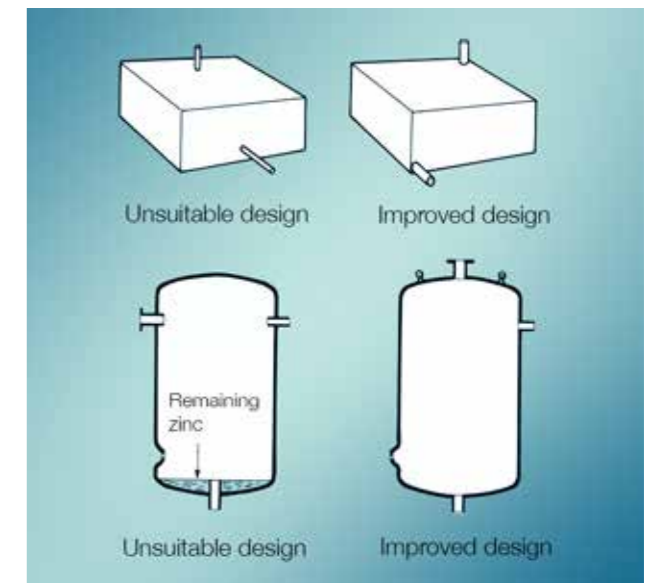

Fig. 7-8. Inwardly projecting pipe connections prevent containers from being completely emptied of zinc and flux. Locate pipe connections near corners and diagonally. It will also be easier for the zinc to run out if the pipe connections are not too small. On large containers lifting eyes should be applied for easier handling.

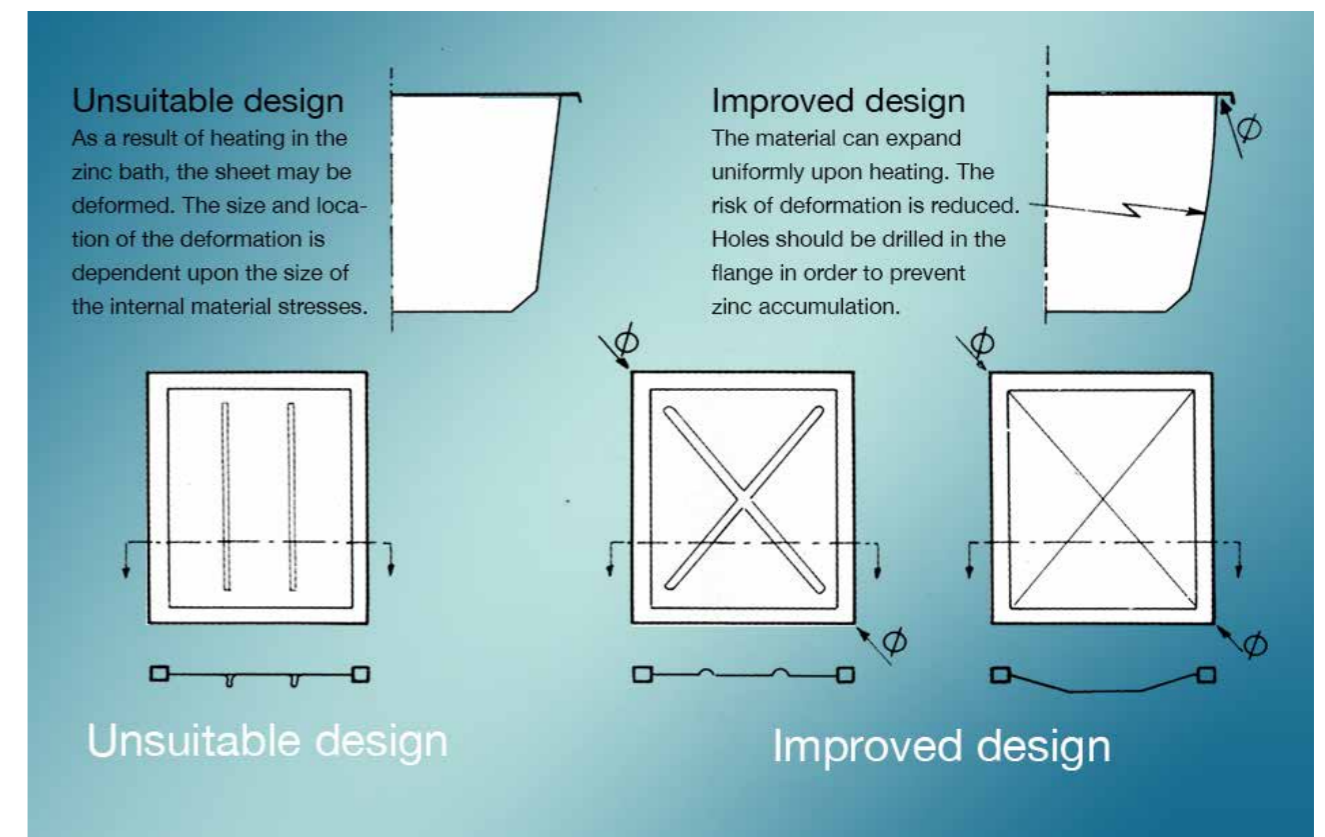

Fig. 7-9. Examples of stiffening of sheet surfaces to prevent distortions.

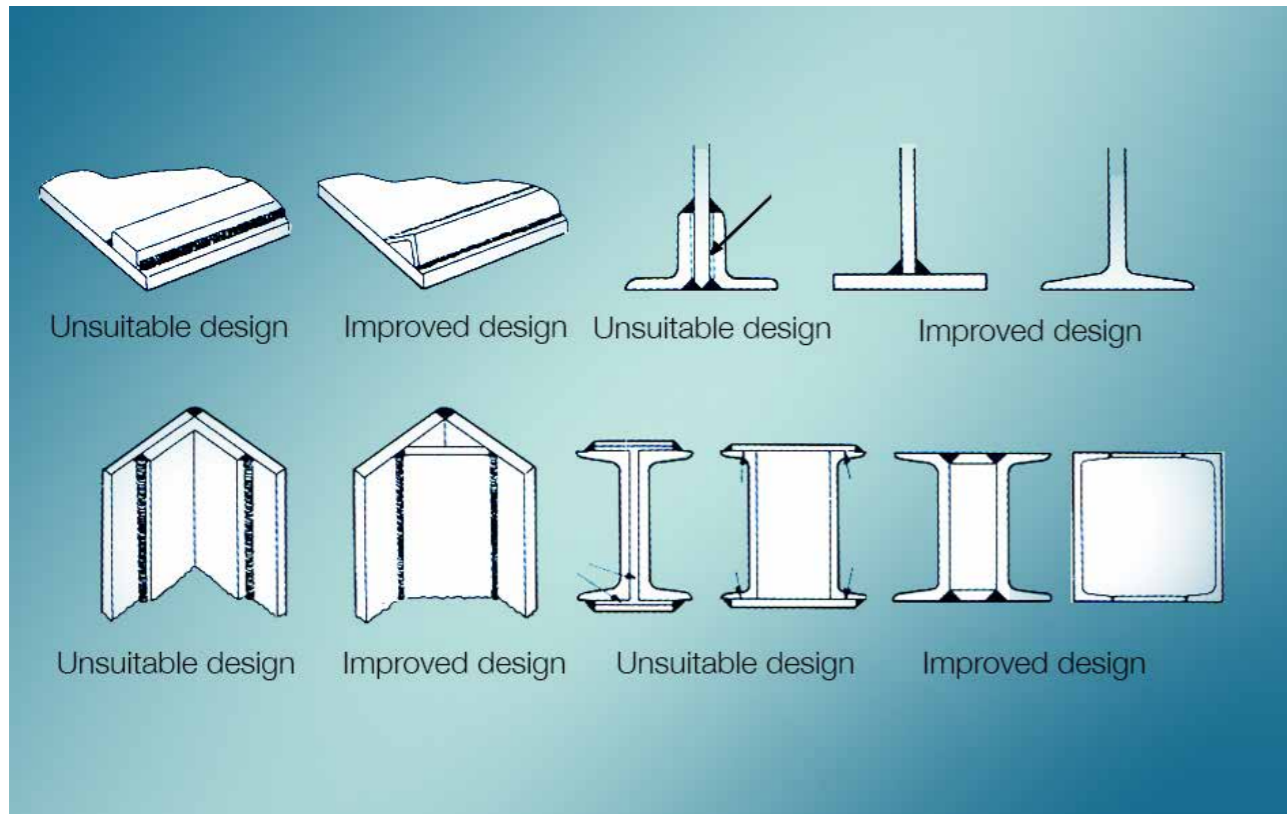

Fig. 7-10. Examples of how weldments should be designed in order to avoid acid traps (narrow crevices).



Fig. 7-11. Acid trap where the acid has corroded through the zinc coating, which leads to discolouration of the surface.

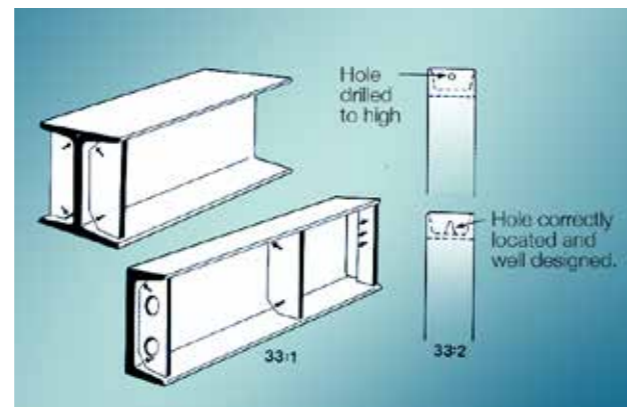
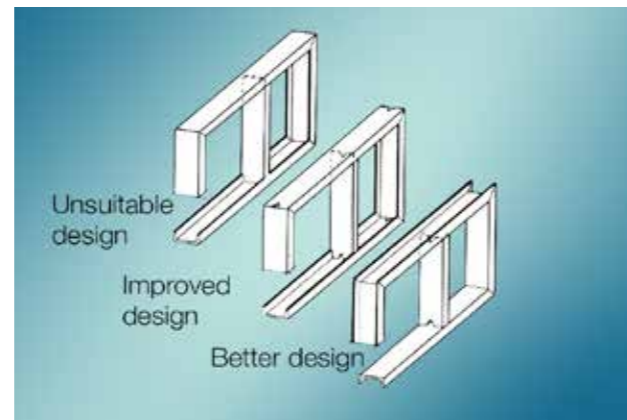

Fig. 7-12. Corners on stiffening plates in e.g. beam webs should be cropped. Drainage holes should be located as close to the web as possible. Diagonals in lattice structures should not run up against frame bars.

7.2.7 Avoid pockets

Structures should if possible be designed so that the zinc can run freely off all surfaces when the object is withdrawn from the zinc bath (fig. 7-12). The coating will otherwise be uneven.

7.2.8 Threaded objects

Male threads must be cut undersize to enable them to fit the respective nuts after galvanizing. Suitable reduction of the thread diameter is given in standards. Female threads are cut or cleaned to nominal size after galvanizing. Male threads in assembled structures must be cleaned after galvanizing. The zinc coating on male threads also protects the steel on internal threads.

7.2.9 Marking

Temporary marking of steel to be hot-dip galvanized should be carried out with water-soluble paint only. Permanent marking can be done by stamping letters or numbers on the object, or to an attached ID plate. Stamping should be to sufficient depth to enable the marking to be read even after galvanizing.

7.2.10 Welding

Welds should be free of pores, which could act as acid traps. In case of double-sided fillet welds, the weld must be continued over the ends of the sheet to prevent the penetration of acid into any conceivable crevice (fig. 7-13).

Welding methods which do not produce slag, such as MIG welding, are preferable. If coated welding electrodes are used, all slag deposits should be carefully removed from the weld. It is not possible to remove welding slag through normal pickling, and any residue causes the formation of black spots during hot-dip galvanizing.

7.2.11 General

A pre-requisite for good results in hot-dip galvanizing is clean steel surfaces. One should therefore try to keep the surfaces free of paint, grease, oil and tar.

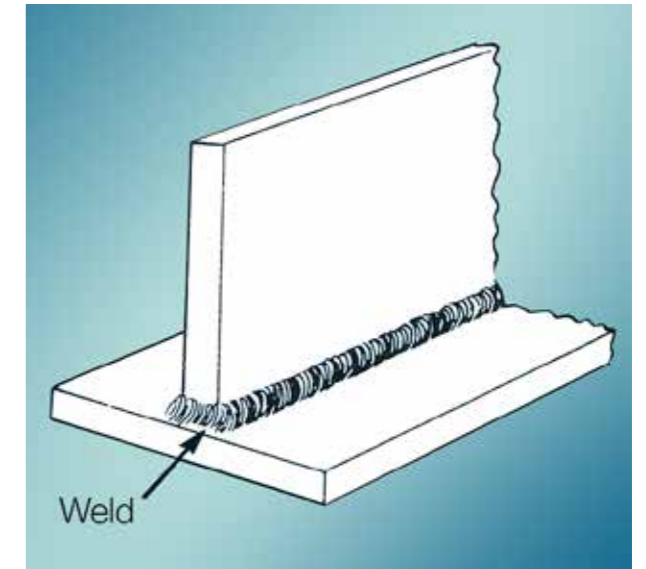

Fig. 7-13. Seal the ends on a double fillet weld so that acid cannot penetrate into the gap.

Impurities such as these cannot be removed by pickling and result in black, uncoated spots after galvanizing. Surface contaminations in the form of grease, oil, tar, paint and welding slag require removal by means of degreasing, sandblasting or grinding. Contamination may be difficult to detect. If it becomes apparent after galvanizing the article may need to be regalvanized, which increases costs.

Thermal cutting heats the steel and produces surfaces that react differently when galvanized. The coating thickness may be lower than expected and the adherence to the steel surface may be poor. The cut surfaces should therefore be ground to remove the heat affected zone before galvanizing.

8. Standards

For batch galvanizing specified quality requirements and testing methods are given in the international standard EN ISO 1461, "Hot dip galvanized coatings on fabricated iron and steel articles - Specifications and test methods". Further information regarding zinc for corrosion protection is available in standard ISO 14713 "Protection against corrosion of iron and steel in structures - Zinc coatings - Guidelines and recommendations: Part 1 General", and "Part 2 - Hot Dip Galvanizing."

8.1 General requirements

According to the standard the coating quality, thickness, structure and physical and chemical properties are influenced by steel composition, mass and the conditions during the hot-dip galvanizing process. Requirements for information between galvanizer and customer are specified in a series of appendices to the standard.

Normally the minimum quality requirement regarding coating thickness and surface appearance are in accordance with EN ISO 1461.

To make it possible to fulfill these above requirements, the customer should inform the galvanizer about steel composition and desired coating thickness according to standard.

8.2 Thicker coatings than required by standard

In some cases, thicker coatings than those defined in EN ISO 1461 may be required. For example, in more aggressive environments or when extra durability is

Article and its thickness	Local coating thickness (minimum) μm	Mean coating thickness (minimum) μm
Steel > 6 mm	70	85
Steel > 3 - \leq 6 mm	55	70
Steel \geq 1,5 - \leq 3 mm	45	55
Steel < 1,5 mm	35	45
Castings \geq 6 mm	70	80
Castings < 6 mm	60	70

Fig. 8-1. Coating thicknesses required by EN ISO 1461. For some aluminum-killed steels these thicknesses could be difficult to achieve, see chapter 5.8.1.

needed. In the Nordic countries thicker coatings may be ordered after agreement between customer and galvanizer. Information about how to achieve thicker coatings is given as a national appendix to EN ISO 1461, see fig 8-2. In fig 8-3 optimal and range values for silicon content which is required to achieve these thicker coatings are given.

8.3 Other standards

In Sweden, sectoral standards for the following aspects are given; Coating thickness control, Cleaning after galvanizing, Coating adherence testing. For products with threads, special standards exist. In these standards, information about undercutting of outer threads (screw) or over cutting of inner threads are given. Thin sheet is hot-dip galvanized according to EN 10346.

Article and its thickness	Fe/Zn 115		Fe/Zn 165		Fe/Zn 215	
	Min. local coating thickness	Min. mean coating thickness	Min. local coating thickness	Min. mean coating thickness	Min. local coating thickness	Min. mean coating thickness
Steel > 6	100	115	145	165	190	215
Steel > 3 to \leq 6 mm	85	95	100	120	115	140
Steel \geq 1 to \leq 3	60	70	70	95		

Fig. 8-2. Coating thickness in microns according to national annex NA to standard EN ISO 1461. If the customer wants thicker coatings than in standard, see Table 8-1, this must be agreed with the galvanizer. To get the steel sufficiently reactive material with higher silicon content is needed, see fig. 8-3.

Coating thickness (μm)	Optimal silicon level (%)	Silicon range (%)
Fe/Zn 115	0,18	0,15-0,21
Fe/Zn 165	0,25	0,22-0,28
Fe/Zn 215	0,32	0,29-0,35

Fig. 8-3. Optimal and range values for silicon when higher coating thicknesses are required.

9. Quality – control, testing and actions

The minimum quality requirements regarding coating thickness and surface appearance are set out in the standard EN ISO 1461. To make it possible to fulfill the requirements of the standard the customer should inform the galvanizer about steel composition and desired coating thickness (picture 8-1).

9.1 Sectoral standards

The Nordic Galvanizers organization has, together with the galvanizing companies, produced sectoral standards for:

- Coating thickness measurements
- Cleaning after galvanizing
- Coating adherence testing

The sectoral standard "Coating thickness control" gives advice on how to measure local and average coating thickness. In particular, local coating thickness is often measured wrongly, since a single measurement is often taken for the local value. Instead, a limited testing area should be defined where three to five measurements are performed. The average value of these measurements gives the local coating thickness value. Then the average value of three to five testing areas is the average coating thickness for the product.

The sectoral standard "Cleaning" gives three different classes which can be chosen depending on quality requirements. Information is included about the maximum area allowed to be uncoated and how to repair it, for example by painting with zinc rich paint or by coating with zinc alloy repair sticks.

The sectoral standard "Adherence control" gives information about how to evaluate the adherence between zinc coating and steel and what can be expected on different types of zinc coatings. The requirements are different depending on whether the surface consists of pure zinc or iron-zinc alloy. During testing, a v-formed stamp hits the surface with a specific spring force.

These sectoral standards are available from www.nordicgalvanizers.com.

The above standards give the basis for the control and testing that is performed at the galvanizing plants.



Fig. 9-1. Coating thickness measurements.

9.2 Coating thickness

For batch galvanized products magnetic measurement methods according to a given standard are most often used. They are quick and easy to perform and do not harm the coating or the product. In fig. 9 -1 this equipment is shown in operation.

In case of disagreement between customer and galvanizer a microscopic analysis method is used.

9.3 Coating surface appearance

When the surface of a hot-dip galvanized object is studied with the naked eye, the surface should be smooth and free of visible faults such as blisters, barbs, zinc ash, flux residue and uncoated areas. Lumps, drops and thick runs are not permitted where they can affect the use of the hot-dip galvanized object. The coated object should be clean and undamaged.

Since the appearance of the surface depends on the silicon content of the steel chosen by the customer, the presence of darker grey areas, a cell-like pattern of dark grey lines between lighter grey areas, do not qualify as reasons for rejection. Since the appearance also depends on both the customer's and the galvanizer's handling of the material, aberrations may occur. It is important that both customer and galvanizer have agreed on the functional demands. If the customer has special requirements for the appearance and smoothness of the coating, this should be discussed at the time of order.

9.4 Adherence between coating and steel

What usually is meant by adherence is the coating

resistance against mechanical loads, for example bending, turning or striking. These properties are very important on continuous galvanized products, but are of less importance for batch galvanized steel. Depending on the coating structure, some zinc coatings may stand higher mechanical load than others. To date, no reliable method to measure adherence has been available, but today there is a method that is able to consider the coating structure.

Performance and requirements of the method are given in the sectorial standard "Coating adherence testing".

9.5 Actions in case of surface aberrations

Depending on the type of aberrations actions may be necessary. In the case of uncoated areas over 0.5 % of the surface, regalvanizing should be carried out unless otherwise agreed with the customer.

When judging the evenness of the zinc layer, it should be understood that hot-dip galvanizing involves dipping in molten metal. The molten metal must then run off the surfaces of the object as it is withdrawn from the bath. This means that the appearance of the zinc layer cannot be compared with an electroplated object, or with mechanically wiped objects such as sheet, wire or tubing.

Certain irregularities such as "curtain formations", thickenings and small amounts of oxides from the bath surface cannot always be avoided. Their acceptability depends on the size and shape of the object, on its manageability in the zinc bath and its intended use. Different parts of the galvanized construction often have shorter or longer dipping times, which influence coating thickness.

Wet storage stain, corrosion of the zinc surface, is not a reason for rejection, since it is often caused by the handling after the steel left the galvanizing plant. In most cases, wet storage stain does not need any corrective action since it disappears during outdoor exposure.

Small defects which do not influence the function of the product or seriously harm the appearance should not be addressed. Mechanical work of the surface, for example grinding, often causes more harm than good.

When welding galvanized steel, the coating around the welding joint are vapourised, and this area together with the joint is unprotected and has to be taken care of.

9.6 Actions in case of damage

If a galvanized surface is damaged, repairs shall be performed with care, to ensure good corrosion protection of the repaired area. To achieve such corrosion protection, cleaning of the damaged area

is very important. If the coating flakes off, the gamma and delta layer often remain at the surface and the remaining coating thickness is 5-10 µm. In such cases, light brushing with a stainless steel brush is enough to remove corrosion products that may have formed on the surface. After that, the damaged area can be painted with zinc-rich paint. Note that that spraying gives thin repair coatings and therefore has to be repeated several times. If a brush is used the repair layer is thicker. To be sure that the layer has reached at least 100 µm, which is in accordance with the standard, measurements shall be performed, see chapter 9.2. If the surface is hard to clean, grinding or blasting may be necessary.

During cleaning loose zinc flakes in the border between coating and damaged area have to be removed. Otherwise the zinc flakes will "raise" during repair, especially if zinc spraying is used.

If damage is recognized immediately after galvanizing, when the steel is still hot, zinc alloys are a good method of repair. Black spots for example may be repaired by this method.

For galvanized surfaces that will be painted it is very important that the repair is performed with special care. The borders between coating and damaged area have to be very smooth, since "edge effects" will otherwise be visible under the paint.

Repair of welded surfaces should be performed as soon as possible, before they start to rust. Cleaning with a stainless steel brush and then painting with zinc-rich paint is a suitable repair method. If red rust has already been created on the surface, cleaning by grinding or blasting is necessary. More information is given in the sectorial standard "Cleaning".

9.7 Approved Galvanizer - for construction products

Approved Galvanizer means that the galvanizer has completed a certification that is developed for galvanizing companies, and among others has shown that it operates in accordance with the following standards:

EN ISO 1461
EN ISO 14713-2
EN 1090-2 (relevant parts)



Approved Galvanizer has been developed by Nordic Galvanizers, MVR (Mekaniska Verkstäders Riksförbund) and the certification body Nordcert, together with galvanizers and customer representatives. The purpose is to support galvanizers' customers in the best way and make it easy and secure for manufacturers of steel structures to choose galvanizing for corrosion protection.

10. Corrosion of zinc coatings

Steel is the most common material in use today. However, steel have one large disadvantage - its high corrosion rate. The protection of steel structures and components is therefore of great economic importance.

The best corrosion protection for steel is obtained with zinc. Zinc coatings on steel protect against corrosion in two ways:

- By a barrier effect, i.e. they prevent oxygen and moisture from reaching the steel surface.
- By giving cathodic protection at scratches, chips, edges etc.

Zinc is a metal with a relatively low galvanic potential and a large tendency to corrode. However, the corrosion rate is low in most environments, since the surface of the coating is quickly covered with corrosion products, which subsequently protect against further corrosion.

10.1 Corrosion in the atmosphere

When a hot-dip galvanized object leaves the zinc bath the surface of the object is immediately attacked by oxygen in the air. The resultant oxide layer has very little ability to protect against corrosion. However, water and carbon dioxide in the air quickly change the oxide layer to zinc carbonates. These give a sealed layer with very good adhesion. Since the carbonates have very low solubility in water they give excellent protection to the surface of the zinc coating (15). The original shiny surface with a metallic lustre disappears to be replaced by matt, light grey colour (fig. 10-1).

Outdoor air contains greater or lesser amount of corrosive elements — gases, soot, humidity (fog, dew, rain, snow), inert and aggressive dust. Levels can vary with location and the time of the year. Sulphates and sulphites of zinc are water soluble and have poor adhesion to the zinc surface. They are therefore washed away easily by rain. A fresh zinc surface is then exposed to attack by oxygen in the air and the corrosion cycle is repeated. Corrosion in air containing sulphur oxides is therefore greater than in clean air. However, the amount of sulphur dioxide in the atmosphere has decreased drastically during recent years (fig. 1-1), and consequently zinc corrosion has also decreased.

In marine environments, the corrosion of zinc is influenced by the salt content of the air. However, marine air contains small quantities of magnesium salts, with good passivating influences. Corrosion is therefore



Fig.10-1. Exposed surface of a zinc coating with outer layer of pure zinc. The shiny surface disappears to be replaced by grey corrosion products (sometimes called zinc patina).

not as great as might be expected. The salt content of the air reduces quickly away from the coast.

The corrosion of zinc is influenced by many factors. This means that a generally applicable formula for corrosion rates cannot be given. Zinc coatings have, however, been used for a long time, under a wide range of conditions, to protect steel from rust. A large number of long-term tests have also been conducted. Knowledge about the corrosion of zinc and corrosion rates in different environments is therefore good. Today, there are examples of zinc coatings that have been exposed for more than one hundred years.

The colour of corrosion products varies according to the environment in which they are formed. Marine environments give somewhat whiter corrosion products compared with rural and urban environments. Corrosion products are usually darkest in urban environments.

10.1.1 Reddish-brown discolouration

Some hot-dip galvanized steel can adopt a reddish-brown colour after a period of exposure. After prolonged exposure — particular in sulphur-rich atmospheres — this discolouration can gradually turn black. The discolouration occurs mainly on coatings of iron-zinc alloy on silicon-killed steels. The source of discolouration is the corrosion of Zn-Fe alloy to form rust together with humid air or rain water. Rust has



Fig. 10-2. Discoloured surface on lighting column.

a great ability to stain and even small amounts can cause considerable discolouration.

Sometimes when discolouration is severe it is easy to conclude that rust protection has been greatly reduced, or completely destroyed. However, this is seldom the case. The iron-zinc alloys give better protection (up to 30–40%) to the underlying steel than pure zinc (16). If appearance is important, discoloured surfaces can be painted. An investigation of a discoloured lighting column that had been exposed for 30 years, showed that 70 μm of the zinc coating still remained on the surface – enough to protect the steel for about another 50 years!

10.2 Corrosion in liquids

The zinc surface is generally covered with a protective layer of corrosion products when it is submerged in a liquid. However, liquids can be acidic or alkaline and can contain dissolved or solid particles of aggressive substances. The temperature and flow rate of the liquid are also of significance. All this means that the protective layer can have a highly varying composition or may not form at all.

Electro-chemical corrosion, which plays a subordinate role in air, is of greater significance in liquids. The extent of electro-chemical corrosion depends on the electrical conductivity of the liquid, which affects the protective influence of the zinc layer over greater or smaller areas.

The pH value of the liquid is of most significance.

The corrosion rate of zinc is normally low and stable in the pH range of 5,5–12,5, at temperatures between 0 and 20 °C. Corrosion outside this range is usually more rapid.

Hard water, which contains lime and magnesium, is less aggressive than soft water. Together with carbon dioxide these substances form sparingly soluble carbonates on the zinc surface, protecting the zinc against further corrosion.

Soft water often attacks zinc, since the absence of salts means that the protective layer cannot be formed. In some waters, polarity reversal can occur at about 70 °C so that the zinc coating becomes more electro-positive than the steel and pitting occurs. Oxygen, sulphates and chlorides counteract polarity reversal, which means that the problem may exist only in very clean water.

Aggressive soft waters can be found in some rivers and lakes in Finland, Norway, Sweden and similar environments.

If the flow rate is higher than 0.5 m/s the formation of the protective layer on the zinc surface is inhibited and corrosion accelerates.

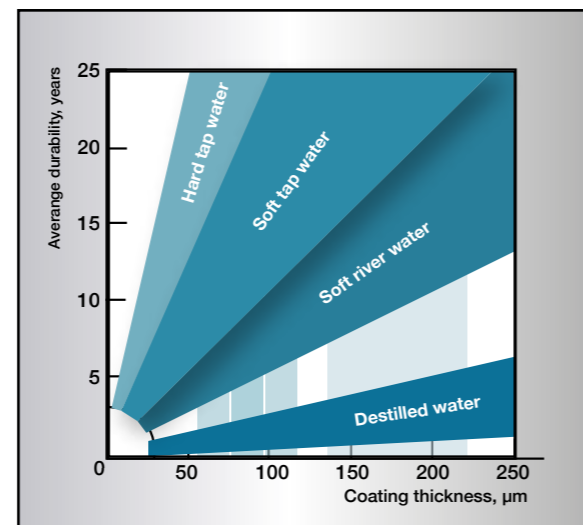
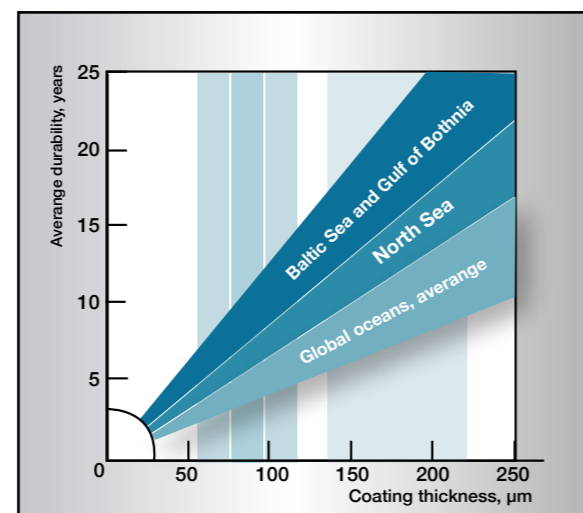

Fig 10-3. Service life in different waters.



Water temperature is of great significance to the rate of corrosion. Above approximately 55 °C, the layer-forming corrosion products acquire a coarse-grained structure and lose adhesion to the zinc surface. They are easily dislodged and expose new, fresh zinc for continued and rapid corrosion attack. The rate of corrosion reaches a maximum at about 70 °C, after which it declines so that at 100 °C it is about the same as at 50 °C.

The corrosion sequence in water is very complex and is influenced heavily by very small variations in the composition of the water. It is therefore difficult to give generally applicable rules. The information in figure 10-3 is based on practical experience and gives guidelines for some different types of water. Otherwise, references 17, 18, 19 and 20 are recommended as sources of further information.



Fig 10-4. Wet-storage stain.

10.2.1 Wet-storage stain

Sometimes a white, floury and voluminous layer called wet-storage stain, or white rust, appears on galvanized surfaces (fig. 10-4). White rust forms on materials with newly galvanized, shiny surfaces and especially in cre-

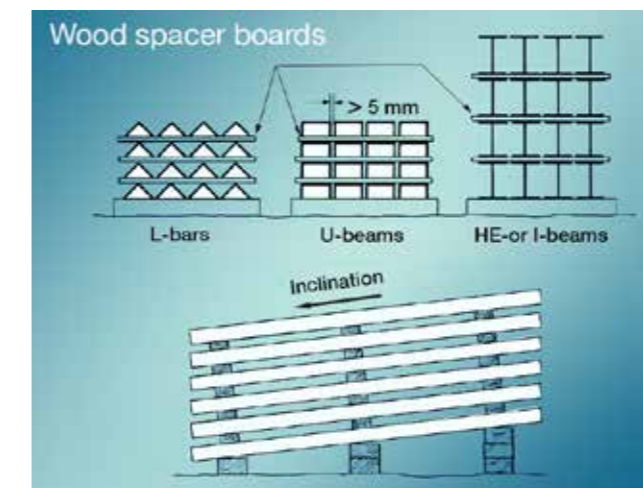

Fig. 10-5. In order to avoid the formation of wet-storage stain on newly galvanized surfaces, profiled steel, beams and structures should be packed at an angle and turned to prevent the accumulation of water.

VICES between closely packed sheets, angle-iron and similar materials. A pre condition is that the material is exposed to condensation or rain water in conditions where the moisture cannot evaporate quickly. Zinc surfaces that have already received a normal protective layer of corrosion products are seldom attacked. When zinc coatings are exposed to air, zinc oxide and zinc hydroxide are formed. Under the influence of carbon dioxide in the air these are converted to basic zinc carbonates. If air access to the zinc surface is restricted, as in narrow crevices, then the area receives insufficient carbon dioxide to enable the normal layer of carbonates to form.

The wet-storage stain layer is voluminous and porous and only loosely attached to the zinc surface. As a result, protection against continued attack does not exist. Corrosion can therefore continue as long as moisture remains on the surfaces. When wet-storage stain has occurred, the object should be stacked to enable the surfaces to dry quickly. This will stop the attack and, with free access to air, the normal protective layer will be formed. The wet-storage stain is gradually washed away and the coating acquires an appearance that is normal for exposed, hot-dip galvanized steel.

Since this white corrosion product is very bulky (about 500 times that of the zinc from which it was formed), it can appear to be serious. However, wet-storage stain often has little or no significance on the service life of the corrosion protection. In the case of very thin coatings however, e.g. on electroplated objects, a severe attack of wet-storage stain can be of significance.

Wet-storage stain is best avoided by preventing newly galvanized surfaces from coming into contact with rain or condensate during transportation. Materials stored outdoors should be stacked so that water can run off easily and so that all surfaces are well ventilated (fig. 10-5). Painting after galvanizing gives very good protection.

Wet-storage stain that has already formed can be removed completely or partially by moderate mechanical or chemical treatment.

Soil type	Aggressivity
Lime, calcareous marl, moraine, sand marl	Small
Sand gravel	Moderate
Clay, peat, bog, humus-rich soils	Great

Fig. 10-6. Corrosiveness of different soil types.

10.3 Corrosion in soil 10.4

The corrosion conditions in soil are very complicated and variations can be great between different locations, even those in close proximity to each other. Soil can contain weathered products, free or bound salts, acids and alkalis, mixtures of organic substances, oxidizing or reducing fungi, microorganisms etc. Depending on its structure, soil has different degrees of permeability to air and moisture. Normally, the oxygen content is less than in air, while the carbon dioxide content is higher.

Nordic soils are generally not very aggressive (fig 10-6). Average corrosion for zinc is usually taken as 5 µm per year. Severely aggressive soils are seldom seen. In north and west Bothnia, soils may contain sulphur.

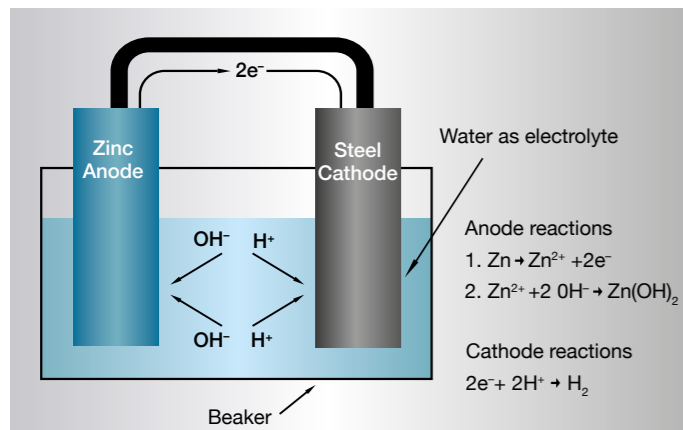

Fig. 10-8. Galvanic corrosion of zinc in contact with steel in water.



Fig. 10-10. Electrochemical potential scale in sea water at + 25 °C.

Nr	Agressiveness	Soil Condition	Resistivity in ohm	Method of protection
1	Low	Dry	> 100	Hot-dip galvanizing > 200 µm
2	Low	Moist	> 450	Hot-dip galvanizing > 200 µm
3	Moderate	Dry	< 100	Hot-dip galvanizing > 200 µm plus a rust allowance on the basis material of 0.5 mm on each side.
4	Moderate	Moist	150 - 450	Same as for 3
5	High	Moist	50 - 150	Hot-dip galvanizing > 200 µm and rust allowance of 1 mm on each side.
6	Very High	Moist or if in certain case H ₂ SO ₄ can form	< 50 - 100	Same as for 5 but rust allowance of 1.5 mm on each side.

Fig. 10-7. Soil aggressiveness at different resistivity levels. Suitable corrosion prevention systems (19).

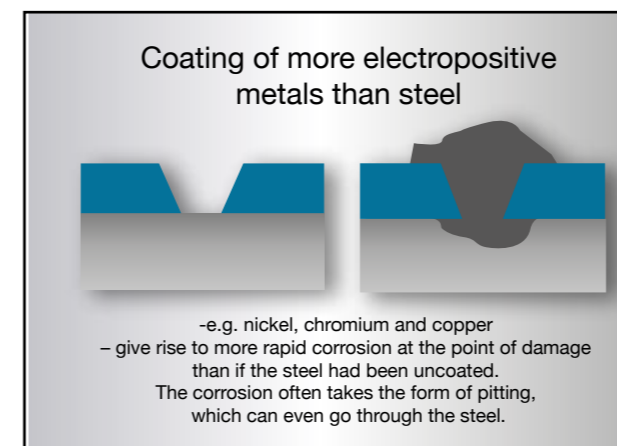
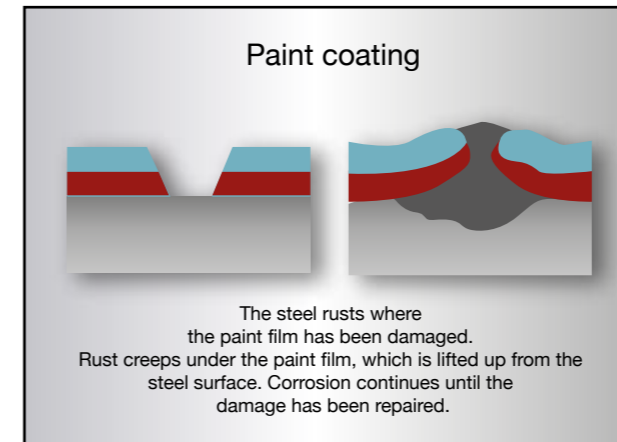
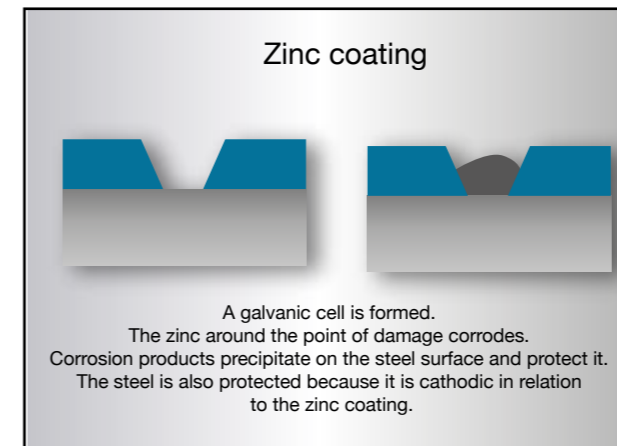

Fig. 10-9. Schematic picture of damage for different rust-prevention coatings.

They are often black, but lighten when exposed to air. In these soils, zinc corrosion rates are very high. One method of determining the corrosiveness of a soil is to measure its resistivity (fig. 10-7) If the resistivity of the soil cannot be determined, the rules-of-thumb listed in figure 10-6 can give a measure of guidance. Where the exposure of metals to soil is concerned, however, it is advisable to seek expert advice from suitably qualified sources.

10.4 Galvanic corrosion

If two different metals or alloys, completely or partially surrounded by an electrolyte, are connected a galvanic cell is created. Which metal becomes the anode or cathode is determined by their electrode potentials in the electrolyte in question. In sea water, which corresponds to the majority of practical conditions, some metals and alloys take up different positions on the electrochemical scale, shown in fig. 10-10.

If steel is connected to copper or brass, the steel becomes the anode in the cell and corrodes. However, if steel is connected to cadmium, aluminium, zinc or magnesium, it becomes the cathode and is protected against corrosion, while the anode metal is consumed (fig. 10-8). Galvanic corrosion is also called bi-metallic corrosion and is used to protect underwater structures from corrosion, when it is termed cathodic protection.

10.4.1 Cathodic protection afforded by zinc coatings

In hot-dip galvanized steel, zinc and steel are in good electrical contact with each other. If the zinc coating is damaged in the presence of an electrolyte a galvanic cell is created. The electrolyte could be condensate or rain water. Sometimes the entire structure can be submerged in liquid. In this cell the zinc becomes the anode or dissolving pole, the exposed steel becomes the cathode and is therefore protected from corrosion.

In the initial phase it is often possible to see a weak rust formation on the exposed part of the steel surface where the coating has been damaged, but after a while whitish-grey areas form which gradually spread over the entire damaged area (fig. 10-11). The zinc coating corrodes and sparingly soluble zinc alloys descend to the cathode surface where they protect the steel from continued rust attack. This is often called "self-healing", which is something of a misnomer since the zinc layer is, of course, not restored.

Owing to the cathodic protection generated by the zinc, rust cannot "creep in" under the coating at the



Fig. 10-11. 6 mm-wide milled groove through 60 µm thick zinc layer on steel exposed for 5 years in severe industrial-marine environment in Holland. Note the coating of zinc salts in the groove, and the total absence of rust breakthrough. (J F H van Eijns-bergen).

point of damage in the way that it can creep under films of paint or coatings of metals more noble than steel (fig. 10-9).

Zinc coatings on steel are unusual, since a fairly large area of damage to the coating does not cause catastrophic loss of rust protection. The range of cathodic protection is dependent on the nature of the electrolyte that creates the cell. For structures in normal atmospheres it is usual to expect protective action over several millimetres. However, in sea water significantly greater distances can be expected.

10.4.2 Galvanic corrosion of galvanized steel in contact with concrete embedded reinforcement

If hot-dip galvanized steel gets in contact with reinforcing steel embedded in concrete, and an electrolyte is present in connection with the hot-dip galvanized steel, a galvanic corrosion cell can be formed. This problem has been noticed both in road environments where hot-dip galvanized poles have come into contact with bridge reinforcement and in animal stables, where contact has been created to equalize the building.

When reinforcement bars of black steel are cast into concrete, it becomes passivated (noble), which means that it has a corrosion potential corresponding to stainless steel. If the stable interior, which is usually hot-dip galvanized, is connected to the embedded reinforcement, this gives rise to a galvanic cell, where very rapid corrosion processes of the zinc have been noted in some cases.

When the zinc corrodes away, the attack on the underlying steel continues, which means that poles and strips can corrode over time. The reason is that the steel in the stable interior has a corrosion potential that is considerably more negative (base) in liquid, manure or moist bedding, compared with the corrosion potential of the concrete embedded steel that has been passivated. Although it is the same type of steel, the different environments in which the material is used cause the concrete embedded steel to become cathode and the moisture-exposed anode in the galvanic cell.

In galvanic corrosion the size of the cathode (nobler metal) and the anode (base metal) also plays an important role. In this case, the reinforcement mat (the cathode) has a large volume relative to the hot-dip galvanized steel, whose anode surface consists only of the local minor region (s) where the electrolyte is in contact with the metal. This unfavourable size ratio further contributes to the accelerated corrosion process.

The corrosion attacks are found, for example, on

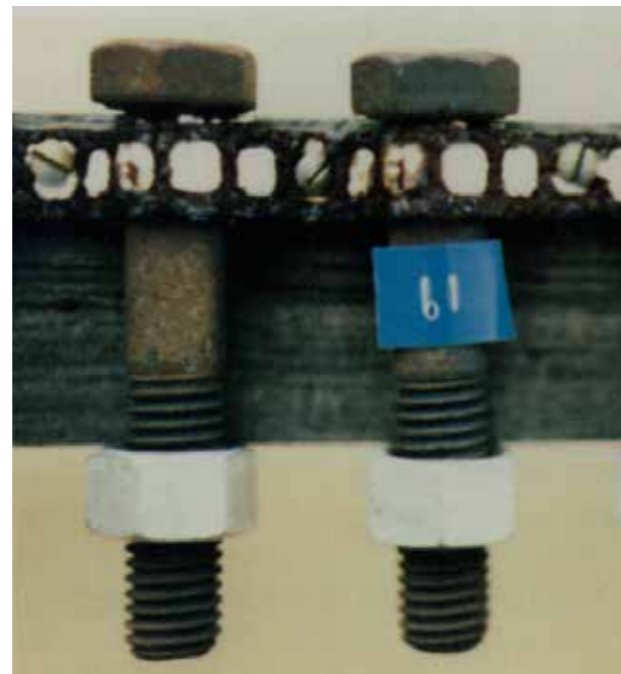

Fig. 10-12. Hot-dip galvanized bolts with stainless acid-proof nuts after 15 years of exposure to a marine environment. No galvanic corrosion!



Fig. 10-13. Brass bolt in hot-dip galvanized steel on a parking deck.

interior details in the animal boxes' lower parts, which are exposed to urine and manure, or in connection with the animal's water cup. The speed of the corrosion process depends on a number of factors.

The relationship between dry and wet time for the exposed surfaces, the type of stable bedding, the behaviour of the animals and the stable system all affects the corrosion process. Generally, it can be said that bed material with high absorbency usually produces a drier environment and reduces the risk of accelerated corrosion processes.

In road environments, the galvanic corrosion occurs in the lower edge of the posts, where electrolyte in the form of rainwater, snow slush and road salt occurs.

To interrupt corrosion, either the contact between the

hot-dip galvanized steel and the concrete embedded reinforcement, or the contact between the hot-dip galvanized steel and the electrolyte, must be broken. The latter can for example be achieved through structural changes or insulation with paint or other material, which is applied to the hot-dip galvanized steel in the exposed areas.

10.4.3 Zinc coatings in contact with non-ferrous metals

Fig. 10-10 shows that zinc is less noble than most common metals. This means that when zinc is connected to these metals in a galvanic cell it is the zinc that becomes the dissolving pole. In principle, therefore, such connections should be avoided when possible. A good method is to use an insulator such as plastic or rubber at the joint.

Aluminium and stainless steel can often be connected directly to galvanized material in air or fairly dry environments without noticeable corrosion taking place (fig. 10-12). However, in water an insulator should always be used.

Copper and copper alloys are more electrically active and there is often a release of copper ions which spread over large surfaces and cause noticeable attack. For this reason, these metals should never be allowed to come into contact with galvanized steel and an insulator should be used (fig. 10-13).

10.5 Hot-dip galvanized steel in contact with building materials

10.5.1 Mortar, plaster and wood

Damp mortar and plaster attack zinc. The attack ceases when the material dries out. Dry or moderately damp wood, both impregnated and unimpregnated, can be nailed with hot-dip galvanized nails to good effect. However, in the case of nails or threaded unions that are constantly exposed to water an acid-resistant material is preferred. Other dry building materials, such as mineral wool, do not attack zinc.

10.5.2 Corrosion protection for reinforcing steel

Reinforced concrete is an important construction material. Highway bridges, car parks, houses, office buildings, gulleys are examples of reinforced concrete structures. In many cases, its steel reinforcement does not need any external corrosion protection to avoid corrosion. The highly alkaline environment of concrete forms a thin oxide layer on the steel surface which protects or "passivates" the steel against further corrosion.

But, in some instances that passivation does not work well enough, or even not at all. This may occur when:

- The concrete has cracks, cleavages, sand pockets or too little cover.
- The alkaline environment has been neutralized (carbonation).
- Chlorides have penetrated the concrete (marine environment, winter prepared roads)

These situations often occur in the outermost parts of a construction. Defects in reinforced concrete have increased because of increased salting and atmospheric impurities. Defects in different concrete constructions are more common today than previously recognised (fig. 10-14). Once corrosion of the reinforcement has started it is very difficult and expensive to repair. The need to protect reinforcement from corrosion is becoming increasingly important in several concrete applications.



Fig. 10-14. Spalling of cover layer over reinforcement in basement, due to the corrosion of reinforcement bars.



Bild 10-15. Hot galvanized reinforcement in bridge.

The possibility to protect reinforcing steel with hot-dip galvanizing is well documented by case histories in many countries. Many slender constructions use hot-dip galvanized reinforcement to avoid spalling which leads to expensive repair. It is also worth noting that concrete debris that may fall from a cracked surface may cause serious harm, especially in urban areas.

Designers have been known to request that the section of a steel construction that is to be set into concrete should be free from zinc. This request is

totally unnecessary and to prevent one part of a construction from zinc coating during galvanizing is often more expensive than galvanizing the whole construction. Designers should be reassured that the adherence between the hot-dip galvanized surface and the concrete is normally so strong that a sledge hammer is needed to separate them (21).

Zinc has been used as sacrificial anode to protect ships' hulls, harbour constructions, cisterns and similar structures against corrosion. Of the available metallic coatings hot-dip galvanizing has been shown to be the most durable and technically suitable. Hot-dip galvanizing of reinforcement steel for concrete has been used worldwide for many years. Even in very severe conditions this surface treatment has shown to be a reliable choice.

Detailed studies, for example in Australia and at the research institute RISE KIMAB in Sweden (21) have shown the following results:

- Accelerated corrosion only takes place during at maximum the first 36 hours after pouring the concrete. After that, the coating is passivated. The loss of zinc is low, in the range 2-5 µm.
- Zinc gives cathodic protection on exposed steel surfaces, which is a benefit when cutting or welding the reinforcement or when it is mechanically damaged.
- The adherence between reinforcement steel and the concrete is good.
- Concrete spalling does not occur.
- The risk for discolouration of the facade due to rust runs is eliminated.
- By galvanizing it is possible to use reinforced concrete in more aggressive environments
- Variations in concrete quality could be accepted.
- Thinner concrete cover can be allowed.

10.5.3 Hot-dip galvanized reinforcement in chloride environments

Practical experiments performed by RISE KIMAB have shown that zinc copes very well even in chloride-containing environments. Up to 1.5 wt. % chloride in the concrete leads to negligible corrosion of the galvanized rebar. Conversely, unprotected reinforced steel had difficulty to cope with this chloride concentration and was corroded. Zinc can withstand even higher chloride concentrations, but with a related decrease in coating life. In such an environment unprotected steel in addition to normal corrosion also will show pitting corrosion, which does not occur on galvanized steel. Also in carbonated concrete, galva-

nized steel is more durable than unprotected steel. Hot dip galvanized reinforcement is a reliable partner in concrete technology. It minimizes the risk of steel corrosion and concrete spalling and gives a strong and cost effective contribution to the durability of the concrete.

When cost and other consequences of corrosion damage of a construction are analyzed, the extra cost for galvanizing is negligible. It could almost be considered as an insurance premium - which only has to be paid once.

Even when the price of galvanized reinforcement may be up to 50 % more than black steel, it is still a negligible part of the overall budget for a construction.

10.6 Packing and transportation of galvanized steel

Even though a hot-dip galvanized coating is capable of withstanding fairly rough treatment it should be handled with care during storage and transportation. In case of long goods simple packing and binding into bundles not only protects against mechanical damage but it often facilitates transportation itself. However, packing and binding should be done in such a way as to avoid risk of wet storage strain. Spacers should be used to prevent such attacks (fig. 10-16 and 10-17.)



Fig.10-16. Hot-dip galvanized goods ready for delivery.



Fig.10-17. Goods packed in an aerated and shock-proof way.

11. Painting of hot-dip galvanized steel — Duplex systems

Many analyses have shown that a duplex system, i.e. hot-dip galvanizing plus painting (fig 11-1), is a most cost effective way to protect steel, particularly with regard to its service life up to the first re-painting. Although hot-dip galvanizing alone usually gives fully satisfactory protection against corrosion, additional protection is sometimes desirable in aggressive environments. It can, for example, be advantageous if future maintenance is likely to be difficult to carry out, or if the zinc coating is thin, as on continuous galvanized thin sheet steel.

Aesthetic reasons — giving the matt grey zinc surface a more pleasing appearance — can also play a role. Similarly, paint can be used to give prominence to or warn of the existence of a structure, or even the opposite — to camouflage the structure. Insulation against galvanic corrosion if the galvanized steel is to be connected to another metal, such as copper, can be another reason for painting.



Fig 11-1. The lighthouse Pater Noster is one of the first duplex treated steel constructions in Sweden. It was galvanized 1868, and after that painted

11.1 Service life of the duplex system

A duplex system generally has a much longer service life than each individual coating. Dutch experiments (22) show that the service life of the system can be calculated according to the following formula:

$$L_T = K(L_{Zn} + L_p)$$

L_T = the service life of the duplex system in years

L_{Zn} = the estimated service life of the zinc coating in years (in the actual environment)

L_p = the estimated service life of the paint coating in years (in the actual environment), if it is applied directly to steel

K = environment-dependent factor between 1,5 and 2,3:

1,5 when the system is exposed in corrosivity category C5 (see fig 2-2) or in sea-water.

1,6 – 2,0 when the system is exposed in corrosivity category C3- C4 or when the wet period for the system is lower than 60 %.

2,1- 2,3 when exposed in corrosivity category C2.

The synergistic effect is explained in picture 11-2. Of course, the galvanized surface must have been correctly pretreated to ensure lasting paint adhesion. To obtain this, the zinc surface must be cleaned thoroughly and the correct type of paint must be used. The painting of zinc-coated surfaces requires somewhat more care than some other materials. Small quantities of impurities on the zinc surface, or the incorrect paint type, can lead to premature blistering and/or flaking.

It was often recommended in the past that the zinc surface should be exposed outdoors for 1-2 years before painting. The recommendation was correct before 1950. At that time the atmosphere, at least in Scandinavian countries, was relatively clean, which meant that the corrosion products that formed on a zinc surface consisted almost entirely of basic zinc carbonates.

Therefore, after a period of exposure, paint was not applied to a reactive zinc surface but to an inert layer of carbonates. The result was generally good, even with paints which would today be regarded as unsuitable. Today this method is suspect since the atmosphere contains sulphur oxides pollution and the corrosion products of zinc often contain water-soluble zinc salts. Paint applied to such a layer, which is to some extent water-soluble, will probably blister or flake, regardless of the paint system.

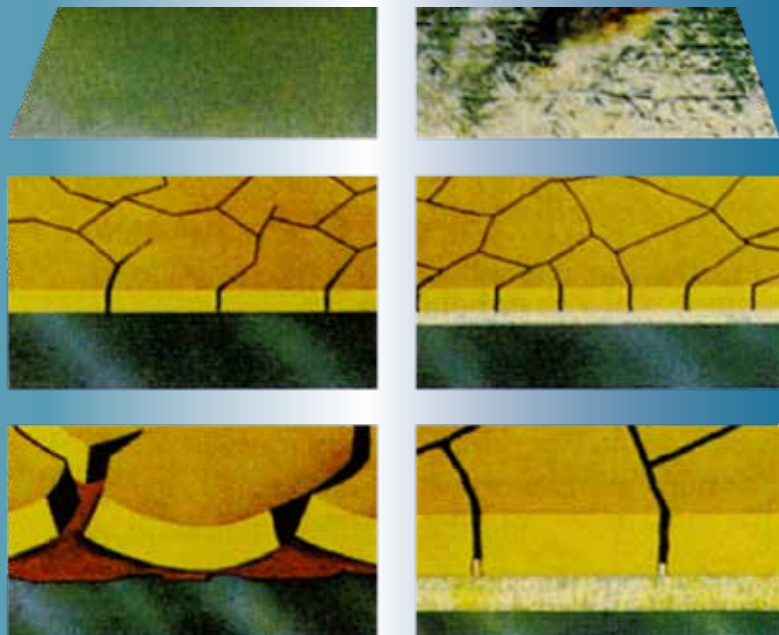

Fig. 11-2. To the left: Schematic drawing showing how micro-cracks in paint coatings on steel give rise to underfilm rusting and flaking. To the right: Micro-cracks in paint coatings on galvanized materials are filled with corrosion products from the zinc, but these have a smaller volume than rust from steel and do not cause flaking.

chromate layer is somewhat water soluble, and painting over a film of oil seldom meets with success. Layers such as these must therefore be removed before painting. Chromating is, for environmental reasons, nowadays replaced by other methods of passivation.

11.2 Newly-galvanized, shiny surfaces

A shiny zinc surface is often considered to be clean enough to paint. In many cases this is not true, and this leads to poor results.

A freshly galvanized surface is a good substrate for painting only if:

- The article has not been water quenched. Quench water is seldom clean. Different salts that may be deposited on the zinc surface can later decrease or totally destroy the adherence of the paint coating.
- The article has not been stored inside the galvanizing plant. The air in the plant contains flux dusts (particles of zinc and ammonium chloride). These particles adhere to the surface and create a water soluble film which reduces the adherence.
- The article has not been stored or transported outdoors in a damp atmosphere. The risk of condensation, which leads to wet storage strain, is significant. It is not always visible to the naked eye, but will cause problems after painting.
- The article has not been stored more than about six hours between galvanizing and painting. The precise critical time is, of course, dependent of the cleanliness and dryness of the surrounding air.

VA "fresh" zinc surface is seldom as clean as one can be led to believe by the lustre. Thin films of oil and grease from gloves, shoes and hoisting slings can increase the impression of a shiny and clean surface. Contamination exists in thin films which are transparent and very difficult to spot with the naked eye. Hot-dip galvanized thin sheet is often chromated or oiled for protection against wet-storage stain. The

11.3 Exposed, matt surfaces

Exposed matt zinc surfaces are always covered with corrosion products. Their composition is difficult to determine. As a rule-of-thumb, it should be assumed that they contain water-soluble or hygroscopic salts



Fig. 11-3. Poor adhesion of a yellow high-gloss alkyd topcoat over a grey chlorinated rubber based primer. The primer adheres excellently to the galvanized steel, whereas the alkyd topcoat does not adhere to the primer (22).

which make them unsuitable substrates for painting. It follows that some form of cleaning is always necessary before matt surfaces are painted. Paint coatings are always more or less permeable to water. This means that if the water-soluble products are not removed from the zinc surface, blisters full of solution will form beneath the paint coating. Access to protective film forming substances is poor in the salt solution and results in corrosion of the zinc layer. Corrosion spreads between the paint and zinc and the corrosion products dislodge the paint coating.

11.4 Cleaning and surface preparation

All experience shows that sweep-blasting gives the best foundation for good adhesion between paint and zinc. Its moderate mechanical effect removes all corrosion products and other impurities from the surface, even the water soluble products. Agents that protect against wet-storage stain are removed effectively, as are different types of oil. Many zinc surfaces are very flat and shiny. For these, blasting is beneficial since it creates a key on the surface which enables better mechanical anchorage of the paint coating.

Recommended data for sweep-blasting of galvanized surfaces is given in fig. 11-4. It is important that the instructions given in the table are followed. Inadequate cleaning may impair paint adhesion while excessive mechanical working can destroy the zinc layer or cause built-in stresses, which could subsequently cause the paint coating to flake.

When sweep-blasting is performed correctly about 10 µm of the zinc layer is removed. If sweep-blasting cannot be used industrial lacquering according to the following procedure is recommended:

1. Alkaline degreasing
2. Thorough water washing
3. Phosphating (zinc phosphate)
4. Thorough water washing
5. Drying
6. Lacquering

Blasting agent:	Aluminium oxide, or corundum, silicates, olivine cinders
Grain size:	0,2-0,5 mm
Nozzle pressure:	0,2-0,3 MPa
Nozzle distance:	300-500 mm
Angle of impact:	30-60 °
Environmental conditions:	20-25 °C, < 50 REH
Surface coarseness:	Fine according to ISO 8503/2 (G)
Priming:	Latest 20-45 min after blasting

Fig. 11-4. Blasting data for sweep-blasting of zinc coatings. More information is given in (23).

Chromated goods require alkaline de-greasing and sometimes brushing, or treatment with nylon wool impregnated with a grinding agent of aluminium oxide. The phosphate layer should be as thin as possible, but should give continuous full cover of 2—4 g/m². A thickness under 1 µm is usually considered to be optimal.

In the case of manual painting, de-greasing with an emulsifying degreasing agent is recommended, preferably combined with brushing or lapping with nylon wool and thorough rinsing with water — high pressure if possible.

Some commercial degreasing agents contain oxide-dissolving additives. This can be an advantage when the composition of the corrosion products is not known.

11.5 Choice of paint

The types of paint recommended below can be applied directly to hot-dip galvanized steel after it has been cleaned. If other paints are to be used a suitable primer, preferably an epoxy primer, must first be applied to the zinc surface.

When choosing paint, it should be remembered that a paint can contain up to 10—15 different components. Each manufacturer has his own formula for a given type. Suppliers of raw materials also have different formulae for binding agents, which means that the number of variations can be very great. Paints of the same type, but from different manufacturers, can therefore have different properties. The guidance below should therefore be regarded as general guidelines only. If in doubt, discuss your selection of paint with the manufacturer's representatives.

Where hot-dip galvanized surfaces are to be painted, it is recommended that the painting systems in EN ISO 12944-5: 2018 are used. Painting of hot-dip galvanized goods is stated in Table D.1 This table describes suitable painting system for corrosivity class C2 - C5, with different durability times. The painting systems have the designation "G" (Galvanized). "

11.6 Powder Coating

Different types of powder coatings are becoming more common on hot-dip galvanized steel. If the requirements on surface finish is very high, the whole surface can be grinded to remove all tags and drops that can interfere with the appearance. In addition, grinding gives very clean surface with the best conditions for optimum adhesion. The galvanized steel pass through a number of pretreatment baths before powder coating. Degreasing, rinsing, etching, rinsing, phosphating and sealing are examples of process

steps that can be included. After that the steel has to try. The powder is applied electrostatically, and after that the steel is transported into the curing oven.

11.6.1 Pinholes

Pinholes are small holes in the coating layer, which can vary in size from small to larger pores. Pinholes is primarily an aesthetic problem. The corrosion protection is still good because of the good protective effect from zinc, but the surfaces may look less appealing. The main reason for pinholes to form is presence of moisture and white rust on the galvanized surface, which give rise to gas formation during the curing process.

To avoid / reduce the risk of pinholes, the following should be considered:

- The zinc surface should be free from contaminants and roughness.
- Avoid exposing the goods in a damp environment - avoid white rust formation.
- Select the right steel for galvanizing - any material with low silicon content, below 0:03% - which gives a smoother surface and also is more durable when blasting.
- Ensure that the phosphate layer, which is applied before powder coating, has had time to dry properly.
- Preheat the goods.
- Use of special powder quality which counteracts the formation of pinholes.
- Use powder with low viscosity, which easily floats out.
- Thicker layer of powder paint can in some cases cause the pores not to penetrate the layer, and therefore not give visible defects.
- Raise the temperature slowly during curing of the powder coat.

11.7 Advices for duplex treatment

The galvanizer need to know in advance if the steel will be duplex treated, since this means extra demands on the surfaces. Primarily use steel with a silicon content that gives a zinc coating with a layer of pure zinc at the surface. This type of coating can withstand the blasting better. If silicon killed steel has already been used - inform the painter about that. If

painting is carried out by another company than the galvanizer, check that the right skills and equipment are available.



Fig 11-5. "Blue house" Park bench, trash can and bicycle racks in powder-coated, hot-dip galvanized steel.

12. Arc welding of zinc-coated steel- Spot welding

Zinc-coated steels can be welded by all procedures and methods used for black steel without too much difficulty. However, data for welding uncoated material cannot always be used since the coating has some disruptive effects on the welding process. The extent of these effects depends on the thickness of the zinc coating, its composition and its structure.

The main problems that arise are:

- Increased spatter
- Reduced penetration
- Increased pore formation
- Risk of intercrystalline cracking
- Increased fume generation.

12.1 Spatter, penetration, pores and cracking

Spatter is a problem primarily in MIG welding. When welding fillet joints in certain positions the spatter can interfere with the arc. It can also stick in the nozzle of the welding gun and disrupt the feeding of wire. Further, particles from the spatter can stick to surfaces near the weld and impair appearance.

Penetration into the joint diminishes because the zinc coating on the surfaces of the joint disrupts the arc's energy balance, thereby reducing its voltage and current.

Pores are formed when vapourized zinc and gases do not have sufficient time to escape the weld pool before it solidifies. The problem is minimal when using coated electrodes. In MIG welding, especially in the case of double-sided fillet welds, some porosity is not unusual.

Intercrystalline cracks that form in welded goods as a result of zinc penetration occur mainly in joints in material over 13 mm thick when coated electrodes have been used. In MIG welding the corresponding thickness limit is 6.5 mm.

12.1.1 Preventing spatter, reduced penetration, pores and intercrystalline cracking

The problems can be eliminated easily or reduced to an acceptable level if one or more of the following measures are adopted:

- Use an "anti-spatter" agent to prevent spatter from sticking to surfaces and the welding gun in MIG welding.
- Weld with a gap between the joint surfaces - 1.5 mm in MIG welding and 2.5 mm when using coated electrodes. This gives increased penetration, reduces the number of pores and eliminates the risk of intercrystalline cracking (zinc penetration).
- Weld at a lower run speed. Weave the electrode along the joint so that the greatest possible amount of zinc is burnt off in front of the weld pool. This reduces the number of pores and also the risk of intercrystalline cracking.
- Bevel the vertical plate in a joint, so that a K- or 1/2 V joint is obtained. This eliminates intercrystalline cracking and reduces the number of pores. This applies regardless of whether or not the joint surfaces are coated with zinc.

12.2 Choice of electrodes

Electrodes that give a low silicon content in the welded material should be the first choice. This will reduce the risk of intercrystalline cracking in joints in thicker material.

12.3 Fumes

Fumes are always generated during the welding of uncoated steel. They contain varying amounts of iron oxide, ozone, hydrogen, carbon monoxides, nitrous oxides and fluorides. Zinc oxide is generated when welding or cutting zinc coated steel. Zinc oxide is a white compound that is clearly visible in the welding fumes, unlike the gases mentioned above.

12.3.1 Health effects of zinc oxide

The inhalation of newly formed zinc oxide can cause a condition known as zinc fever, or zinc shivers. The symptoms are similar to those of influenza, i.e. fever, fits of shivering, increased salivary secretion, headaches and, in more serious cases, nausea and vomiting. However, zinc is not retained in the body in the same way as for example lead and cadmium, but is excreted in urine and faeces. The symptoms of zinc fever usually disappear within a few hours and long term effects are thought to be minimal.

12.3.2 Protection from welding fumes

Suitable arrangements for the extraction of welding fumes should be made for all welding operations, regardless of whether or not the welded material is coated. Welders should not be exposed to the risk of inhaling welding fumes. However, welding outdoors can usually be performed without the need for special measures against fumes. The manual arc welding of zinc coated steels is dealt with in more detail in references 24 and 25.

12.4 Spot welding

Welding methods applicable to black steel can also be used on galvanized steel. However, it is usual for the welding data — time, current and electrode pressure — to be increased compared with the corresponding figures for uncoated sheet. It must be arranged so that the zinc layer is pressed down at the weld point, otherwise only a soldering between the zinc layers is obtained. Also, owing to the tendency of zinc to alloy with copper, the electrodes must be cleaned more often compared with welding of uncoated material.

Suitable electrode material is copper-chrome or copper-chrome-zirconium alloys. Good results are also obtained with copper electrodes with cemented carbide inserts. The tip of the electrode should be shaped like a truncated cone with a top angle of 120—140°. Good cooling is of great significance to the service life of the electrode.

Correctly performed spot and seam welds do not normally need to be treated against rust.



13. Bolted connections

Bolted connections give excellent performance in hot-dip galvanized structures, with a very long, maintenance-free service life and no weak points in respect of corrosion. Both the hot dip galvanizing process and subsequent transportation to site may be carried out more efficiently when structures are bolted, as opposed to being welded. What is more, the time consuming repair work to surface zones burnt off during assembly welding can be avoided.

With a few exceptions, the same rules can be applied to calculation and assembly as for untreated steel. Hot-dip galvanized nuts and bolts should be used in hot-dip galvanized structures in order to give the whole unit the same level of protection against corrosion. If the bolts are to be tensioned at high torque both the threads and contact surfaces of the components to be tensioned during assembly should be waxed.

13.1 Nuts and bolts

The average thickness of the zinc layer on hot-dip galvanized bolts with threads smaller than M10 is about 40 µm, and about 55 µm for threads larger than M10. The threads in nuts are not galvanized, since they receive protection from the bolt thread.

Bolts up to strength class 8.8 are standard stock items, and class 10.9 can be obtained galvanized by conventional methods. Higher strength classes could

not be galvanized due to the risk of annealing effects and the risk of intercrystalline cracking.

13.2 Contact surfaces

Examples of characteristic values of the friction coefficient on zinc-coated surfaces:

• hot-dip galvanized surface	0.15
• hot-dip galvanized and blasted surface	0.35
• thermally sprayed zinc surface, layer 50 µm	0.30

Hot-dip galvanized surfaces should be brushed lightly with a wire brush before use. If the surfaces are blasted, the technique used is given in chapter 11, "Painting of galvanized steel – Duplex systems".

13.3 Inserting holes

When hot-dip galvanized bolts are used, the hole diameter must be increased by 0.2 mm according to standard. If the structure is to be hot-dip galvanized after the holes have been drilled, the hole diameter must be increased further by 0.3 mm.

13.4 Assembly

Galvanized bolts in strength class 8.8 are tensioned either using a spanner and lever-shank at full human strength, according to fig. 13-1, or with the aid of a machine torque wrench, according to the torque data given in the same figure. For bolts in strength class 4.6, the table values are halved.

Bolt dimension, mm	Lever for manuell tensioning, mm		Torque for machine tensioning, Nm	
	Bolt in delivered condition ¹	Vaxed nut	Bolt in delivered condition ¹	Vaxed nut
12	150	100	60	40
16	200	150	150	90
20	400	200	300	180
22	550	400	400	240
24	700	500	500	300

¹ Nuts ate assumed to have been treated with rust-prevention oil.

Fig. 13-1. Lever and torque for normal tensioning of galvanized bolts in strength class 8.8 .

14. Economic aspects

When the total costs of different rust prevention systems are to be compared, a number of complications become evident, since intervals between individual maintenance requirements can vary. The cost situations at each such interval can also vary. However, the long service life given by zinc coatings, together with the reduced risk of minor damage leading to a significant reduction in protection against corrosion, almost always makes hot-dip galvanizing cheaper than other methods of surface treatment in the long run.

14.1 Initial cost

The choice of rust prevention system is often made only on the basis of purchase price. However, the purchase price says little about the overall economy of the different rust prevention systems.

The maintenance costs of one system can be considerably higher than those of another. This is especially true if access to the structure is difficult; if maintenance causes operational stoppages; if products and machines have to be covered, or if scaffolding has to be erected.

Unfortunately, it is not practical to give a universally applicable answer to the cost of hot-dip galvanizing or other surface treatments. Structures and components vary in size, which affects the ease with which they can be handled and therefore the cost of galvanizing.

The price of hot-dip galvanizing is based on the weight of the goods. It should also be noted that for tubes and hollow articles, both inner and outer surfaces are coated, which not is the case for painting. However, the price of painting is usually based on the surface area. The relationships between average material thickness and surface in m²/tonne are given in the diagram in fig. 14-2.

The initial costs are often generally lower for hot-dip galvanizing than for painting (fig. 14-3) because painting is more labour-intensive than hot-dip galvanizing.

14.2 Maintenance costs

To maintain a corrosion protection system can be expensive, especially when it has to be performed on site. The following costs may be considered:

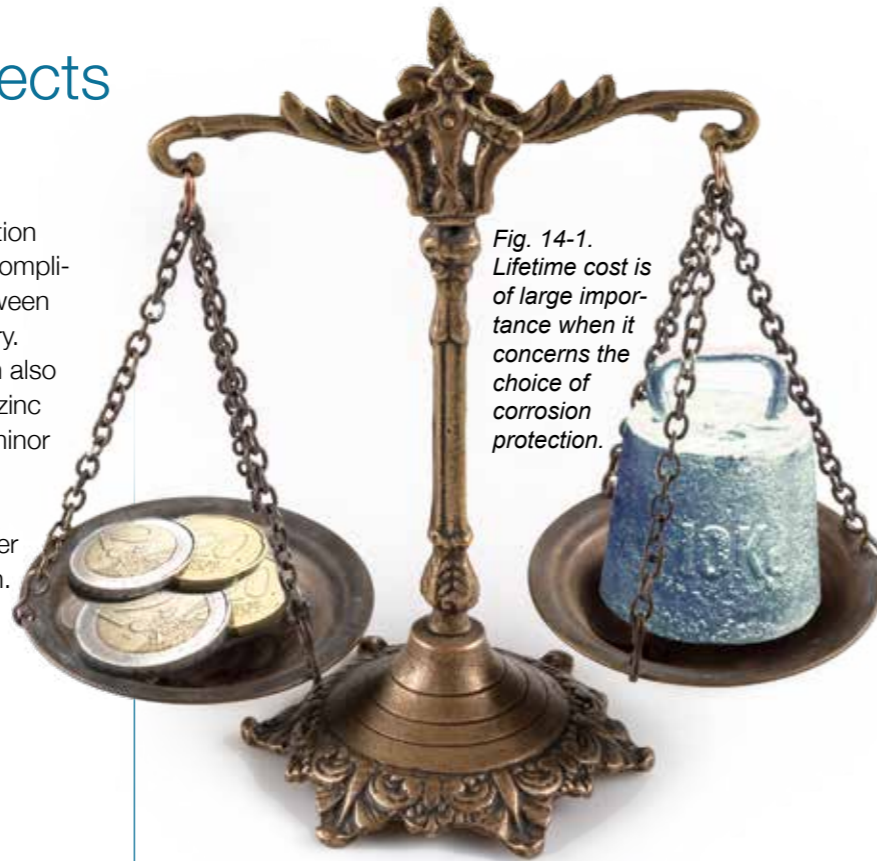

Fig. 14-1. Lifetime cost is of large importance when it concerns the choice of corrosion protection.

- Cleaning old protection system and rust
- Construction of scaffolding and/or ladders
- Handling of the old protection system and disposal
- Special activities for inaccessible areas
- Operational interruptions
- Application of the new protection system
- Transportation

Neglected maintenance could lead to secondary damage, which may create even higher costs. Because of that it is important to select the right corrosion protection system, to minimize or eliminate these service costs.

14.3 Life time costs

Life time costs for a corrosion protection system are the sum of all expenses during the lifetime of a construction. To calculate the lifetime cost can be difficult without a lot of information. Fig 14-4 gives a good estimate of the costs when the corrosion environment corresponds to class C4, see fig 2-2.

To choose a durable surface treatment with low life-time cost is also good for the environment, since it saves raw materials and energy and lowers the carbon dioxide emissions over the life cycle. The remaining zinc on a scrapped construction is also easy to recycle and use again.

Average material thickness in mm

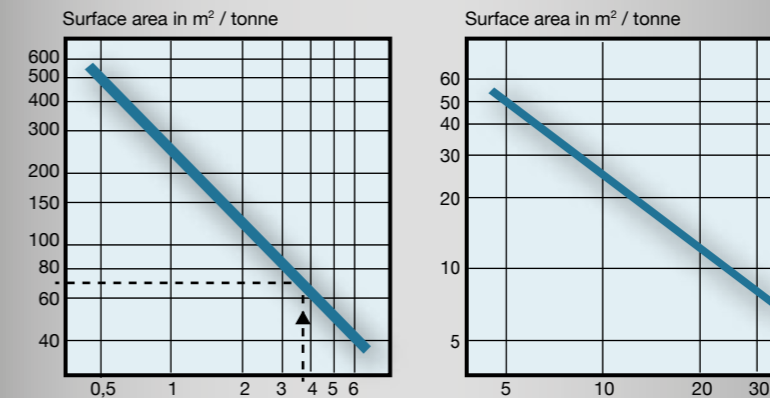

Fig. 14-2. Diagram for recalculation of material thickness in mm to material surface in m² per tonne. (According to H-J Bottcher and J P Kleingarn)

Relative cost

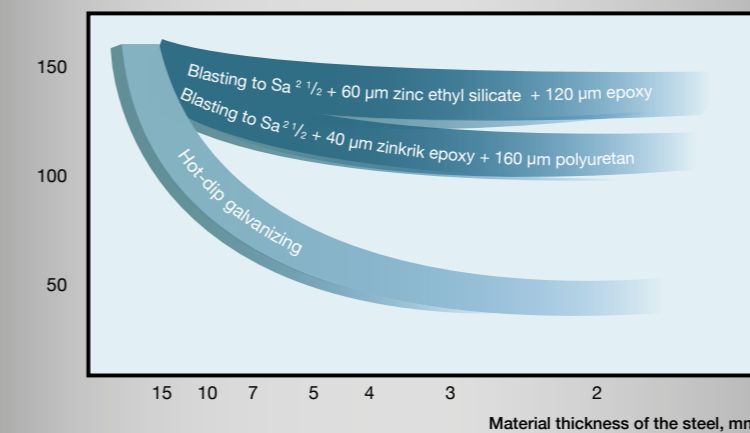

Fig. 14-3. Price relationship between paint systems and hot-dip galvanizing on steel with different material thickness.

Summary of initial and life time costs

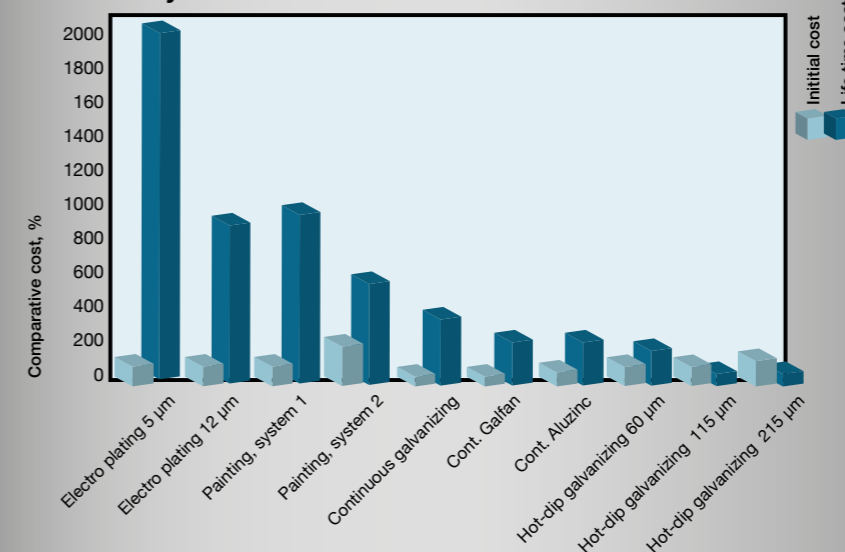

Fig 14-4. When choosing between different types of corrosion protection system it is important to consider life time cost, not only initial cost.

15. Zinc in the environment

15.1 Introduction

Zinc is a light, grey metal, which is relatively easy to extract. The density of zinc is 7.2 g/cm³. Zinc is naturally present in the environment and is the 24th most abundant element in the earth's crust. The average concentration of zinc is calculated to be 70 mg/kg. At the mine, zinc is found in form of zinc blende (a sulphide of zinc).

When zinc is exposed to moist air, a thin film of hydroxide and carbonate is formed on the surface. The film has a low solubility in water and protects the zinc from further corrosion. If high amounts of sulphur dioxide are present in the atmosphere, zinc sulphates form on the surface. Zinc sulphate has higher solubility in water and is more easily washed away, so a fresh zinc surface is exposed to corrosion. However, the level of atmospheric sulphur dioxide has decreased considerably in both Europe and the Nordic countries during the last 20 years and today very low concentrations are measured, fig. 1-1.

15.2 Zinc in organisms

Zinc participates in numerous vital reactions, such as phosphorus metabolism, nucleic acid metabolism, protein and DNA synthesis, detoxification reactions etc. In higher animals and humans, zinc is important for vital brain functions, the immune system and reproduction. In presence of organic substances, zinc ions create complexes together with, for example, amino acids and proteins. This affinity to bio molecules is the reason for the important role zinc plays as an essential micronutrient for all types of organisms. There are 300 different enzymes, in which zinc is known to play a catalytic, structural or controlling role.

Humans need 12-15 mg zinc per day to maintain necessary biological functions and to avoid zinc deficiency. This means that, for example in Sweden, the inhabitants consume about 50 tonnes of zinc during a year. Unfortunately a lot of people in the world suffer from zinc deficiency, which for children leads to diarrhoea, stunted growth and other problems.

Zinc is also used in wound creams, body lotions, baby powder, medicine, sun oils and so on.

For plants, zinc deficiency leads to significantly decreased growth. To counteract this, thousands of tonnes

of zinc are added to fields in fertilizers. In animal breeding, for example, sucking-pigs get zinc in their food to boost immune defence, growth and skin condition. For this purpose alone, about 70 tonnes of zinc are consumed in Sweden each year.

Most systems for assessment of the environmental hazard of chemical substances include as a central criterion the bioaccumulation potential of the substance. This is normally expressed as the substance's bio concentration factor (BCF) and is determined experimentally by exposing aquatic organisms to an aqueous solution of the substance in question. If the BCF value > 100 the substance is considered as having such a high bioaccumulation potential and it can be regarded as environmentally hazardous, according, for example, to the EU directives (26).



Fig. 15-1. Humans need 12 mg zinc per day to maintain necessary biological functions and to avoid infections.

For substances, such as essential metals, whose uptake and accumulation in living organisms is controlled by sophisticated regulation systems, the use of the BCF is of very limited relevance for assessment of environmental hazard. This becomes evident when it is observed that the experimentally-determined BCF value for an essential metal such as zinc shows a very great variation, depending on how the bioaccumulation experiment is carried out. A test organism that is exposed to a low zinc concentration in water absorbs and accumulates more zinc to satisfy its zinc need, resulting in a higher BCF value (26).

- Series of experiments with molluscs showed that the BCFs for zinc varied between 600 and 55,000 in the common sea mussel and between 1,100 and 9,000 in a gastropod species after 8 days of exposure to zinc, despite the fact that the zinc content in the body tissue only varied by a factor of 2.

- For a type of shell, the BCFs for zinc varied between 1100 and 9000 after 8 days of exposure to zinc, despite the fact that the zinc content in the shell only varied by a factor of 2.

It is therefore important to take account of zinc's role as an essential element when applying regulatory criteria.

15.3 Bioavailability of zinc

The bioavailability indicates how easily an organism can take up a particular subject, such as a nutrient, a metal or an environmental toxin. Zinc has the ability to bind in insoluble compounds, which generally have low bioavailability and thus low environmental impact.

15.4 Fields of application

The major application of zinc is for corrosion protection of steel in the form of a coating or as metallic powder in paint, in brass or in other zinc alloys. Zinc chemicals are used in a lot of different areas such as medicines, creams, wood protection chemicals, catalysts, food nutrients for humans and animals, rubber additives etc. Zinc oxide is the most common additive in rubber production, skin protection and wound creams.

In Sweden, 70 % of zinc is used for corrosion protection. A major part of that volume is used for galvanizing of steel sheets and in construction. The annual consumption of zinc in Sweden is 35 000 tonnes and most of this is imported from Norway or Finland.

15.5 Will zinc leave the galvanized surface?

Some people have the notion that the use of metals can be harmful, since they believe that corrosion product "leaks" out and influence on the environment. In order to address these attitudes with well-substantiated facts zinc industry has commissioned extensive studies of zinc content in soil and water close to galvanized products. Even in environments where many sources of zinc exist, such as along highways where zinc can be released from both the tire and road wear, lubricating oil and corrosion, the examinations have shown that zinc does not have any negative effects (30).

"Division for Surface and Corrosion Science" at the Royal Institute of Technology in Stockholm has studied how zinc, copper and stainless steel in roofing materials influence on the environment. During rain a part of the formed corrosion product on the metal surfaces is rinsed away and comes with rain water. The amount of corrosion product run-off depends on several factors, such as the amount of air pollution, chemical composition and pH of the rain and also the length and intensity of it.

The metal present in the rain water which leaves the roof edge, consists mainly of free ions. The study showed that when the metal-containing water passed through a layer of soil, or had been in contact with concrete or limestone, over 96% of the total metal content disappeared. Most of the metal bond very quickly in contact with the soil, and the remaining metal in the water had low bioavailability and thus little opportunity to interact with the environment (30, 31).

15.6 Production and energy consumption

Zinc is mainly produced from the ore sphalerite, which after crushing, concentration and roasting is dissolved in an electrolytic solution. Recycled zinc from, for example, steel-making dust and other raw materials are dissolved directly into the electrolyte. The zinc is separated from the solution using an electric current. Metallic zinc is precipitated onto aluminium cathode plates. The cathodes are then removed from the solution and replaced with new cathodes. The zinc is stripped from the aluminium plates, smelted and cast into ingots. After all the stages in this process are complete, the zinc is a finished and saleable product. The zinc used for hot-dip galvanizing has a purity of 99.995 % of zinc. The remaining 0.005 % consists mainly of iron.

The Swedish Environmental Protection Agency has made a calculation of the relative energy need during primary production of zinc and concluded that its energy consumption is the lowest for all base metals, except iron, calculated both on weight and volume percent. According to one zinc-producing company, the energy consumption is 12-13 GJ per tonne of zinc. Recycling of zinc from galvanized steel sheet only consumes 5 % of the energy given above. Because of that, zinc is very advantageous compared to other base metals, regarding conservation of environmental resources.

15.7 Recycling

During hot dip galvanizing some process waste, or rather secondary raw materials, are generated, from which all the zinc can be recycled. Of a total world annual zinc demand, about 35 % is



Fig 15-2. Almost 80 % of all available zinc is recycled.

met by recycled zinc. Zinc's cycle life is on average 30 to 40 years - which means that almost 80 % of available zinc is recycled. Zinc in used chemicals and the small quantities of zinc which slowly weathers from coated steel is not recycled. This is the same for zinc pigments lost through degradation of paints.

Zinc can be recycled infinitely without deterioration in quality. This means that zinc fits well into a sustainable society. By protecting steel from corrosion for many decades, iron, energy, transport and emissions of mainly carbon dioxide, are reduced.

15.8 Emissions of zinc

a) Point sources

The emissions are principally of two different kinds – emissions to air and emissions to water. In Sweden, zinc emissions to water are largely from point sources, in particular from the waste and forestry industry. The main part of zinc emissions to air are created by waste-fed steel processes working without filters, and from fire wood and peat. The surface treatment in-

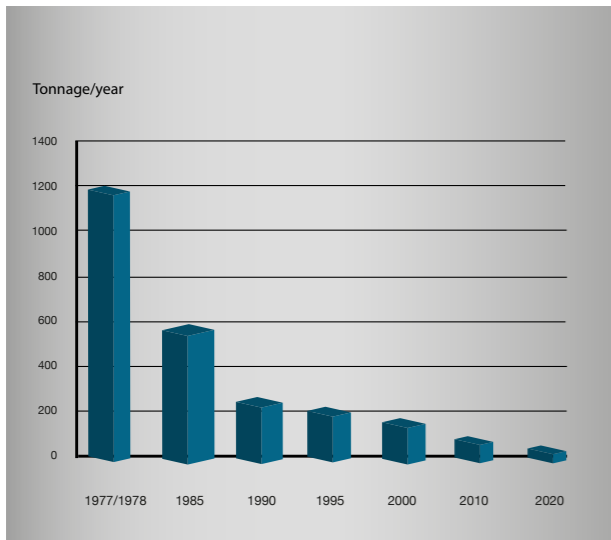

Fig.15.3. Zinc emission to air have declined significantly over the past 30 years (32).

dustry has very effective cleaning equipment and the yearly emission of zinc (2002) in Sweden is only two tonnes. A large hot dip galvanizing plant in Sweden today has an annual emission of zinc of about 20-25 kg, which is four times lower than the limit set by the Swedish Environmental Protection Agency.

Fig 15-3 and 15-4 shows how the emissions to air and water have changed since 1977. To air, the decrease is a factor of 12 and to water a factor 4.5. The lower decrease in emissions to water is because the Falu Mine still has a release of zinc to the environment, even though zinc has never been produced there.

b) Diffuse emissions

Diffuse emissions of zinc are mainly from corrosion, traffic wear (tyres, asphalt, brake lining) and household drainage. A large part also comes from atmospheric deposition, caused by emissions in other countries. The trend is decreasing and the diffuse emissions have been lowered by 40 % during the last 10 years.

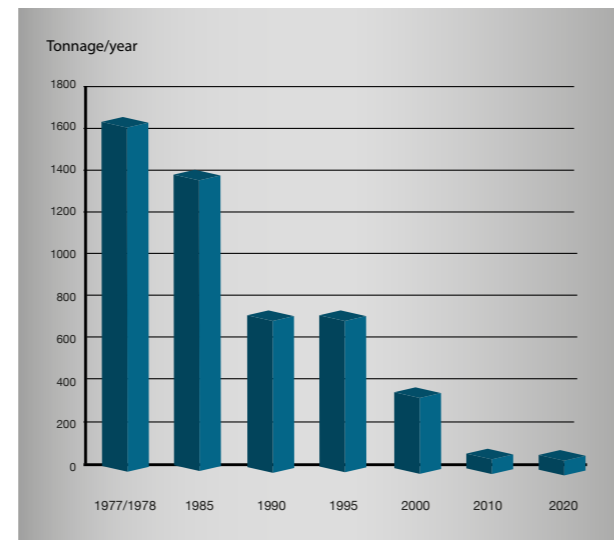

Fig 15.4. Also zinc emissions to water has fallen substantially during the last thirty year period (32).

16. Environmental information

16.1 Environmental activities in galvanizing

Nordic Galvanizers is the association for galvanizing companies in the Nordic countries. The association has an information office located in Stockholm, Sweden. Anybody that has questions regarding galvanizing of steel are welcome to contact that office for help and advice. The information office works on both technical and environmental related areas, on education and on marketing of galvanized steel.

The association's members operate their plants according to the environmental laws and have well prepared:

- Environmental policy
- Environmental report
- Control of chemicals
- Control of internal and external environment
- Required specification from the responsible Environmental Protection Agency

16.2 The product

During galvanizing of components and structures, the steel is dipped into molten zinc, either at a temperature of about 455 °C (low temperature galvanizing) or about 550 °C (high temperature galvanizing) and an alloy of zinc and iron builds up. For low temperature galvanizing, the thickness of the coating is dependent both on the chemical composition of the steel and the dipping time. The thickness of the coating usually is in the range 70-125 µm, depending on steel composition, dipping time and steel thickness. Higher coating thicknesses are also possible, if reactive steel is chosen. Thinner coatings are often bright and shiny whilst thicker coatings have a more dull appearance.

Hot-dip galvanizing is used to protect steel against corrosion. In outdoor environments, galvanized steel with the coating thicknesses mentioned above often have a durability of more than 50 years. Hot-dip galvanizing can be used for most products where a reliable and long lasting corrosion protection at low cost are needed. With life cycles of more than 50 years without any maintenance the life time cost for galvanized products is very low.



Bild 16-1. Galvanized can.

The hot-dip galvanized surface can, after suitable preparation, be painted (i.e., duplex systems), which further extends the protection, since zinc and paint complement each other.

For hot-dip galvanized products, zinc can also provide cathodic protection to the steel, which means that small areas of damage to the coating will not corrode. This is a big advantage when comparing hot-dip galvanizing with painting, since paint does not offer cathodic protection.

16.2.1 Product content

SHG (Special High Grade) zinc is used for galvanizing, which contains a minimum of 99.995 % zinc. The iron content is approximately 0.003% and lead and cadmium each <0.003%, often much lower. The zinc is purchased as ingots which are available in different sizes. The ingots are put into the galvanizing bath where they melt at 420 °C.

Apart from zinc, a small amount of aluminium may

be added to the bath, and in some cases also some nickel. Lead used to be added to the bath but today other metals, for example bismuth, are used instead for environmental reasons.

During hot-dip galvanizing, dross (an alloy of zinc and iron containing about 95 % zinc) is produced. Another waste product is ash (containing about 70 % zinc). The zinc content of both these wastes is fully recycled. Zinc and iron from spent pickling baths or hydroxide sludge created during pretreatment can also be reused. Most galvanizing plants have closed systems and the different residues are recycled.

16.3 Packing and transporting

Hot-dip galvanized products are packed and transported in bundles or on pallets. Galvanized surfaces should not be packaged close together, since rain or moisture in slots may create wet storage strain.

The galvanized coating is more resistant to transport damage than other coatings, such as paint. Transport of the products is mainly performed by trucks. During winter it is important to use covers to protect the galvanized steel from chlorides from road de-icing salts.

16.4 Material recycling and energy consumption

Hot-dip galvanized products can be recycled or re-galvanized since the steel is usually totally intact after the period in use. Zinc in the remaining coating can be recycled as zinc oxide as it is collected in the steel plants' filters.

Zinc is easy to recycle. Today 36 % of the raw material for zinc production is from reused zinc, which is almost 80 % of the zinc available for recycling. Most recycled zinc comes from residues, brass and galvanized steel.

When zinc is produced from ore, the energy consumed is 13 GJ per tonnes of zinc. When remelted zinc is used, the energy consumption is as low as 0,65 GJ, which means that zinc is one of the cheapest metals to produce and also its environmental load is lower than for other metals.

16.5 Production

Hot-dip galvanizing is performed in about 55 plants of different sizes around the Nordic countries. Most of the plants are both quality and environmental certified. Hot-dip galvanizing is often performed without automation because of the variation in product size and volume. Some plants, usually those processing a series of homogenous products, are automated.

16.5.1 Emissions to air

During galvanizing the particulates emitted from the process are collected in a filter. These particulates

can be used for recycling of flux. Combustion fumes, including carbon dioxide or nitrogen oxides, are not created by the process. Thus, galvanizing in closed installations gives very low emissions to air.

16.5.2 Emissions to water

If water rinsing is included between some of the pre-treatment steps, that water is cleaned and recycled. If the products are water quenched after galvanizing the quench water is also cleaned and recycled.

16.5.3 Energy consumption

During galvanizing, 600-650 kWh of energy are consumed per tonne of steel, for a plant operating a single shift. When using three shifts, the energy consumption is 350 kWh per tonne of steel. (Figures from Sweden.) Energy efficiency in the processes is of great importance. Recycled heat from galvanizing and cooling baths is used, for example, for warming of the facilities. Most pretreatment baths operate at room temperature.

16.5.4 Noise and health

The noise from a galvanizing plant is usually low and does not influence the local environment. After about 200 years of hot-dip galvanizing activities, no negative health effects have been identified for people working in or living close to plants.

16.6 Environmental profile

This environmental profile of the galvanizing process gives average values for the materials consumed and produced per tonne of galvanized steel. (Local deviations may exist.)

Component	Consumption per tonne galvanized steel
Zinc	60-70 kg
Electricity, one shift	600-650 kWh
Electricity, three shift	350 kWh
Flux	2-3 kg
Water	Small volumes that are cleaned
Hydrochloric acid	15 kg
Water	Small volumes that are cleaned
Residual components	Production per tonne galvanized steel
Nitrogen dioxide	0 kg
Carbon dioxide	0 kg
Dross	10 kg
Ash	15 kg
Pollution control residuals	0,3 kg
Hydroxide sludge	5 kg

16.6.1 Environmental guidelines

Galvanizers have been active in environmental protection for many years. This includes management of energy and raw materials, prevention of emissions and handling of residuals for recycling. The galvanizing process has developed with appropriate consideration of human health and the environment.

Each galvanizing plant has a person responsible for environmental management. Special routines for handling of process baths and chemicals have been developed. The different processes in the plants are regularly documented and an annual environmental report is produced.

16.7 Zinc in the environment

Zinc is an essential metal which in small amounts is very important for most organisms. A human being needs approximately 12 mg per day, which means that the population around the world consumes about 34 000 tonnes each year.

The anthropogenic emissions of zinc to water and air have decreased with a factor 10 over the last 20 years. Today, emissions from the surface treatment industry are at a very low level of 2-3 tonnes per year.

Measurements of the atmospheric deposition of zinc (using zinc levels in moss as an indicator) shows a value of 40-50 mg per kilogram, which is lower than the natural background concentration in Sweden, which is, on average, about 70 mg per kg dry soil. The Swedish Environmental Protection Agency has raised the permitted concentration of zinc in soil to 100 mg per kg. All measurements and studies show a large decrease in zinc content in our environment and, in fact, several areas show zinc deficiency. To compensate for that, about 1000 tonnes of zinc are spread on agricultural fields each year.

Waste rock from historical mining activities are large point sources for emissions of zinc to water. In particular, there is a release of zinc around Falun, even though zinc has never been mined there. That means that lakes in that area have quite high zinc content (about 400 microgram/litre). In comparison, river water contains about 4 microgram/litre of zinc. Despite the high zinc content in the lakes around Falun, no adverse effects on organisms in these lakes have been reported.

In their book "Zinc in society and in the environment" Landner and Lindeström (26) mention that even though there are high total concentrations of zinc in some areas, there is no evidence of zinc causing any harm to the environment. One explanation may be that zinc very quickly forms stable complexes and mineralizes so that the bioavailable fraction that is exposed to the environment is very low.

16.8 Environmental Product Declaration

The European General Galvanizers Association, EGGA, where Nordic Galvanizers is member, has developed an Environmental Product Declaration for galvanized steel. An EPD is a way to communicate environmental characteristics, and can be used on all kinds of products and services. Environmental Product Declaration according to the standard ISO 14025 is based on life cycle analysis.

An EPD is a good way to meet user and authorities expectations on relevant environmental information. The underlying LCA is additionally an excellent ground to further improving a product's environmental performance. Construction of houses and infrastructure accounts for use of a large part of resources in the world. Because of that environmental issues has become increasingly important during the design and procurement. Different materials have different environmental impact per kg - but also quite different characteristics. New standards for assessing the environmental performance of the whole construction works is therefore necessary for a systematic approach with sustainable construction.

LCI data is a powerful tool when a detailed study of the products and services environmental impact throughout their life cycle should be analyzed. However, LCI data can be difficult to interpret for product users, and it is therefore more and more common to present a product's environmental performance using an Environmental Product Declaration, EPD.

How can you measure and evaluate whether a material or product is environmentally sustainable? A large project to increase the knowledge in this area started in 2004 by galvanizers and zinc suppliers in whole Europe. The aim of the project was to examine how the hot dip galvanizing process and hot dip galvanized steel performs environmentally in comparison with other structural materials and coatings available on the market. The data collection has been updated at several occasions and it now covers over 1000 tons of steel, hot dip galvanized at 66 different plants in 14 countries in Europe. The result represents the average value of a typical, individually galvanized product. Usually an EPD is made for a particular, specific product. In this case, however, a general EPD for a hot-dip galvanized steel sheet of a given size has been made. The EPD can be downloaded at www.nordicgalvanizers.com.

Figure 16-2. The Environmental Product Declaration is based on data from a large number of hot-dip galvanizing plants in Europe and represents the average of a typical batch galvanized product.



17. Referenser

1. Wranglén, G: Metallens korrosion och ytskydd. Almqvist & Wiksell, Stockholm 1967.
2. Mattson, E: Elektrokemi och korrosionslära, Bulletin nr 100, Korrosionsinstitutet, Stockholm 1987.
3. Svendenius G, et al: Korrosion och korrosions-skydd-läromedelsserie, Korrosionsinstitutet, Stockholm 1977.
4. ISO 12944-2:2017: Paints and varnishes - Corrosion protection of steel structures by protective paint systems - Part 2: Classification of environments
6. SIS: SIS handbok 160, utgåva 1, Stockholm, 1986.
7. Ruddle, G E et al: Analysis of the Distribution and Form of Silicon in the Steel Surface as Related to the Galvanizing Reaction. Proc Sec Int ILZRO Galv Seminar. St Louis 9-10 June 1976, ILZRO, New York 1976.
8. Leroy, V et al: Galvanizing of Silicon Containing Steels, Ibid.
9. Hänsel, G: Thick and Irregular Galvanized Coatings, Proc 13 Int Galv Conf, London 1982. Zinc Dev Association, London.
10. Bablik, H: Galvanizing (Hot Dip) E & F N Spon Ltd, London W.C.2, 1950.
11. Horstmann, D: Allgemeine Gesetzmässigkeiten des Einflusses von Eisenbegleitern auf die Vorgänge beim Feuerverzinken. Stahl u Eisen 80 (1960) : 22 1531-1540.
12. Horstmann, D: Das Verhalten mikrolegierter Baustähle mit höherer Festigkeit beim Feuerverzinken. Arch Eisenhüttenw. 46 (1975):2, 137-141.
13. Hirn, A: Användande av förzinkade detaljer vid förhöjd temperatur, delrapport VII för forskningsupp. 4020/92 "Förzinkning av svåra stål", IM-3165, Inst för Metallforskning, Stockholm 1994.
14. Nieth, F: Abriebverhalten von Eisen-Zink-Legierungsschichten und Reinzinkschichten. Metalloberfläche 22 (1968):6, 175-177.
15. Schikorr, G: Atmospheric Corrosion Resistance of Zinc. Zinc Dev Association, London 1965.
16. Kucera, V & Mattson, E: Förbättrade zinksikt för korrosionsskydd av järn och stål. Bull 78. Korrosionsinst., Stockholm 1976.
17. Slunder, CJ & Boyd, WK: Zinc: Its Corrosion Resistance. Zinc Dev Association, London 1971.
18. Schwenk, W & Friehe, W: Korrosionsverhalten Feuer- und Spritzverzinkter Stahlbleche mit und ohne Schutzanstrich auf dem Seewasserversuchsstand des Vereins Deutscher Eisenhüttenleute in Helgoland. Stahl u. Eisen 92 (1972):21 1030-1035.
19. Viktor, V: Korrosion hos zink i sötvatten. Varmförzinkningstekniska konferensen 1962. Nordisk Förzinkningsförening, Stockholm 1963.
20. Wiederholt, W: Korrosionsverhalten von Zink in Wässern. Zinkberatung e.V. Düsseldorf 1965.
21. Vinka, T-G: Korrosion på förzinkat stål och kolstål i karbonatiserad och kloridhaltig betong, Nordisk Korrosion nr 3/2002.
22. van Eijnsbergen, JFH: Duplex Systems Hot Dip Galvanizing plus Painting. The Hauge, 1994.
23. Handbok i Rostskyddsmålning. Bulletin nr 85, upplaga 2, Korrosionsinstitutet. Stockholm 1984.
24. Bland, J: Welding Zinc-Coated Steel. American Welding Soc. Miami, Florida 1972.
25. Thomas, R: Bågsvetsning av zinkbelagt stål. Nordisk Förzinkningsförening. Stockholm 1974.
26. Landner, L & Lindeström, L: Zink – resurs och/eller hot? En faktaredovisning. Miljöforskargruppen, Stockholm och Fryksta 1996.
27. Landner, L & Reuther, R: Metals in Society and in the Environment, AF-Environmental Research Group and enas Environmental Assessments, Sweden and Germany 2004.
28. Jensen T: Koldvalsede/koldformede stål med lave siliciumhold, retningslinier for valg af stål. K5 17607/TJ. FORCE Technology, Danmark, 2006.
29. "Valg af stål til varmförzinkning" utgivet af Foreningen af Danske Varmförzinkere og Nordisk Förzinknings-förening (Nordic Galvanizers) i samarbejde med FORCE Institutets Korrosionsafdeling, Danmark.
30. Tom Wolley and EGGA Working Group: Varmförzinkning och hållbart byggande, England 2008.
31. Odnevall Wallinder I, Prof. Ph. Dr., Division for Surface and Corrosion Science, www.corrosionscience.se, Tekniska Högskolan Stockholm.
32. Hansson K et al, IVL Swedish Environmental Research Institute, Sörme S et al, SCB and Segersson D, SMHI, On behalf of the Environmental Protection Agency, SMED Report No. 106 2012, Fugitive emissions to air and water, 2012.



Hot-dip galvanizing – durable, maintenance free corrosion protection

Hot-dip galvanizing gives steel a long-lasting, maintenance-free corrosion protection in most environments.

This handbook contains information about steel reactivity, advices regarding design, environmental aspects and other important things for those who want to protect their construction against corrosion.

Nordic Galvanizers is the branch association for hot-dip galvanizing companies in the Nordic countries. Customers and users of galvanized steel are welcome to contact us to discuss all types of questions related to hot-dip galvanizing.

Visit our webpage, www.nordicgalvanizers.com, for additional information and news from the hot-dip galvanizing area.

nordic
GALVANIZERS 

info@nordicgalvanizers.com, www.nordicgalvanizers.com, +46 8 446 67 60